



**Guida Tecnica:**  
**Regolatore Digitale DSR**

**Technical Guide:**  
**DSR Digital Regulator**



<b>INDEX</b>	pag. 2
<b>INTRODUCTION</b>	pag. 3
<b>MAIN CHARACTERISTICS</b>	pag. 3
1. Architecture of the system	pag. 3
1.1 Regulator	pag. 3
1.2 Communications module	pag. 3
2. Technical characteristics	pag. 3
3. Inputs and Outputs: technical specifications	pag. 4
4. Block diagram	pag. 5
<b>INSTALLATION</b>	pag. 5
1. Overall dimensions drawings	pag. 5
2. Connections	pag. 6
3. Terminals	pag. 6
4. DSR connections for typical applications	pag. 6
5. Setting up the regulator	pag. 6
5.1 Alternator voltage signals	pag. 6
5.2 Calibrating sensing	pag. 6
5.3 50/60 Signal	pag. 6
6. Serial communications	pag. 10
7. APO Contact	pag. 10
8. VOLT, STAB,Hz and AMP Trimmers	pag. 10
9. Vext Input	pag. 10
<b>SERIAL CONNECTION</b>	pag. 11
<b>PARAMETERS AND OPERATING DATA</b>	pag. 12
1. ModBus registry list	pag. 12
2. Word of configuration (Parameter P[10])	pag. 13
3. RAM location reference, activation of saturation in analog remote control	pag. 13
4. Volatile memory addresses	pag. 14
5. Fourth Status Word (Location L[39])	pag. 14
<b>SETTING OF VOLT, STAB, AMP and Hz PARAMETERS</b>	pag. 15
1. Voltage	pag. 15
1.1 Setting voltage	pag. 15
1.2 Slow voltage variations	pag. 15
2. Stability	pag. 16
2.1 Adjustment of stability	pag. 16
3. Excitation overcurrent	pag. 20
3.1 Description	pag. 20
3.2 Calibration with a supervision unit	pag. 20
3.3 Calibration without a supervision unit	pag. 21
4. Underspeed	pag. 21
4.1 Description	pag. 21
4.2 Calibration with a supervision unit	pag. 21
4.3 Calibration without a supervision unit	pag. 22
5. Overspeed	pag. 22
6. Other parameters	pag. 22
6.1 Vout / Vaux Ratio	pag. 22
6.2 V/F slope at start up	pag. 23
6.3 Short circuit time	pag. 23
<b>CONTROLLING OF REGULATOR ALARMS</b>	pag. 23
1. Table of recapitulation	pag. 23
2. Alarm signals with the indicator lights	pag. 23
3. Description of alarms	pag. 24
4. APO Output	pag. 25
5. Board operation time	pag. 25
<b>DI1 COMMUNICATIONS UNIT</b>	pag. 26
1. Description	pag. 26
2. Inputs and Outputs	pag. 27
3. Powering DI1	pag. 28
<b>USE OF PROGRAMMING SOFT. AND MONITORING OF THE DSR TERMINAL</b>	pag. 29
1. Installation	pag. 29
2. Introduction	pag. 29
3. Description of function	pag. 30
4. Setting Files	pag. 31
<b>APPENDIX A</b>	pag. 34
<b>APPENDIX B</b>	pag. 37

The information contained in this manual may be modified without advance notice.  
This revision supersedes and replaces all previous editions.  
Even partial reproduction of this manual is prohibited, with any means whatsoever, without prior written authorisation by Mecc Alte S.p.A.

## INTRODUCTION

This manual contains information on the operation and use of the DSR digital regulator.



In order to avoid damage to persons and/or property, only qualified personnel, having full knowledge and understanding of the information contained in this manual, should perform the procedures described herein; when power to the unit is on, the voltage present may be lethal for the operator.



All connections must be made with the power off.

The plastic protections on connectors J1 and J2 must not be removed for any reason whatsoever.

## MAIN CHARACTERISTICS

### 1. Architecture of the system

The DSR is a voltage regulator for synchronous alternators, designed for stand alone working and calibration; to maximize performance, the regulator should be understood as part of a system made up of at least three components: the DSR (control unit), a communications module (DI1, for example) and a supervision unit, as illustrated in figure 4 or 12.

The connectors for connection to and from the power generator and communications module are located on the DSR regulator.

The supervision unit can be made up of a personal computer, another “synoptic” device or both; it does not have the function of controlling the system in real time, but allows programming and visualisation of all operational parameters of the DSR.

If it is equipped with an RS485 or RS232 serial interface, the DI1 communications module is necessary for its connection.

#### 1.1 Regulator

Since the regulator is designed to control many different types of generators, it must be appropriately configured to obtain the best performance; most of the settings are stored in a non-volatile integrated memory (EEPROM). The first time the regulator is turned on, a default configuration will be present, which satisfies the most widely requested characteristics and is suitable to facilitate installation: the trimmers are active and the inputs for the external potentiometer and the 60 Hz jumper are enabled, therefore the basic calibrations can be performed without the use of additional equipment.

The regulator is available in two versions called DSR and DSR/A, the first is the standard one, optimized for Mecc Alte alternators from series 3 to 38, the second is optimized for Mecc Alte alternators series 40-46; the two versions differ mainly in some default parameters.

NOTE: the parameter that defines the output voltage (with the VOLT trimmer disabled) is set on 0 (so that the adjustment takes place on the minimum voltage)

#### 1.2 Communications module

The DI1 communications module (which is provided for connection to the COM connector of the DSR) is equipped with a RS232 port and a RS485 port, through which it is possible to set the parameters (for both configuration and operation) and “monitor” operation of the generator.

### 2. Technical Characteristics

- Full digital controlled regulator, based on DSP
- On-board machine installation
- Suitable for all self-regulated alternators
- Voltage supply: 40Vac÷270Vac (from auxiliary winding, output voltage or PMG)
- Frequency range: 12Hz ÷ 72Hz
- “Sensing” of voltage with true rms or average measurement (70÷280 Vac)
- Maximum continuous output current: 4Adc;
- Precision of voltage regulation: ± 1% from no-load to nominal load in static condition, with any power factor and for frequency variations ranging from -5% to +20% of the nominal value.

- Precision of voltage regulation:  $\pm 1\%$  from no-load to nominal load in static condition, with any power factor and for frequency variations ranging from  $-5\%$  to  $+20\%$  of the nominal value.
- Transient power drops and overvoltage within  $\pm 15\%$
- Voltage recovery time within  $\pm 3\%$  of the value set, in less than 300 msec.
- Transient overvoltage during start up: less than 5% of nominal voltage.
- Single phase sensing
- Parameters: VOLT, STAB, AMP and Hz can be set with trimmers (default) 50/60Hz through a “jumper” (default); all parameters can be programmed via software.
- Analogical remote control of output voltage is possible through external voltage ( $0\div 2,5\text{Vdc}$ ) or with a 10 Kohm linear potentiometer.
- Environmental temperature:  $-25\text{ }^{\circ}\text{C} \div +70\text{ }^{\circ}\text{C}$
- Underspeed protection with adjustable threshold and slope
- Overvoltage and undervoltage alarms
- Excitation overcurrent protection with delayed intervention
- Management of temporary short circuits (start up of asynchronous motors)
- Open collector output (not insulated) signalling intervention of protective devices (insulation on optional DI1 module) with programmable activation with respect to the individual alarms and the possibility to delay intervention.
- Abnormal operation conditions storage (type of alarm, number of events, duration of the last event, total time)
- Memorization of the regulator operation time (starting from revision 11 of the Firmware)
- RS232 and RS485 serial communications interface (with optional DI1 module)

**WARNING : Operation of the DSR is not specified below 12 Hz.**

### 3. Inputs and Outputs: technical specifications

TABLE 1 : CONNECTOR CN1				
Terminal <sup>(1)</sup>	Name	Function	Specifications	Notes
1	Exc-	Excitation	Continuous Rating: 4Adc Transitory Rating: 12Adc at peak	
2	Aux/Exc+			
3	Aux/Exc+	Power	Frequency: from 12Hz to 72Hz Range: 40Vac - 270Vac	
9	Aux/Neutral			
4	F_phase	Sensing	Range: 140Vac - 280Vac Burden: <1VA	Measurement of average value (rectified) or actual effective value for voltage adjustment
5	F_Phase			
6	H_phase		Range: 70Vac - 140Vac Burden: <1VA	
7	H_phase			
8	Aux/Neutral			
10	Vext/Pext	Input for remote voltage control	Type: Not insulated Range: 0 - 2,5 Vdc or 10K Potentiometer Adjustment: from $-14\%$ to $+14\%$ <sup>(3)</sup> Burden: 0 - 2 mA (sink) Max length: 30m <sup>(2)</sup>	Tolerates voltages from - 5V to + 5V but for values exceeding the range it is automatically disabled
11	Common			
12	50/60Hz	50/60 Hz Jumper Input	Type: Not insulated Max length: 3m	Selection of underspeed protection threshold $50\cdot(100\%-\alpha\text{Hz}\%)$ or $60\cdot(100\%-\alpha\text{Hz}\%)$ $\alpha\text{Hz}\%$ is the position relative to the Hz trimmer or the percentage value of parameter 21
13	Common			
14	A.P.O.	Active protections output	Type: Non-insulated open collector Current : 100mA Voltage: 30V Max length: 30m <sup>(2)</sup>	Both activating alarm and delay time are programmable
15	Common			

NOTE (1) The terminals are connected to each other on the board: 2 with 3, 4 with 5, 6 with 7, 8 with 9, 11 with 13 and 15.

NOTE (2) With external EMI filter SDR 128/K, see Fig.10 (3m without EMI filter)

NOTE (3) Starting from revision 10 of the Firmware. It is convenient do not exceed  $\pm 10\%$

TABLE 2 : TRIMMERS		
Name	Function	Notes
VOLT	Voltage Calibration	From 70Vac to 140Vac or from 140Vac to 280Vac, see paragraph "Setting the voltage"
STAB	Calibration of dynamic response	Adjustment of proportional gain, see paragraph on "Stability"
Hz	Calibration of underspeed protection intervention threshold	Variation up to -20% with respect to the nominal speed value set in jumper/parameter 50/60.
AMP	Calibration of excitation overcurrent protection	See paragraph "Calibration of excitation overcurrent protection"

#### 4. Block diagram

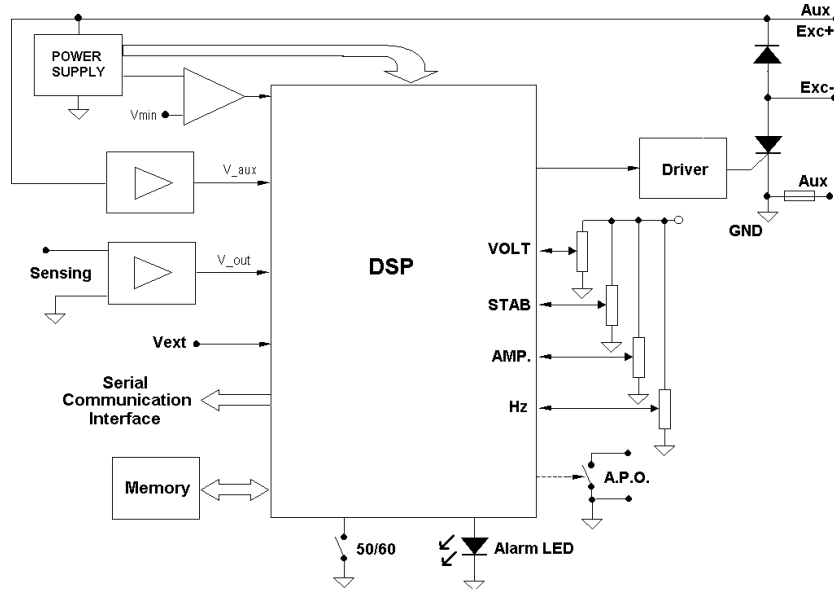

fig. 1

## INSTALLATION

Upon receipt of the digital regulator, perform a visual inspection to ensure that no damage has been sustained during transportation and movement of the equipment. In the event of damage, advise the shipper, the insurance company, the seller or Mecc Alte immediately. If the regulator is not installed immediately, store it in its original packaging in a dust and humidity-free environment.

The regulator is normally installed in the generator terminal box. It is fixed with two M4x20 or M4x25 screws and must be installed in a location where the temperature does not exceed the environmental conditions foreseen.

### 1. Overall dimensions drawings

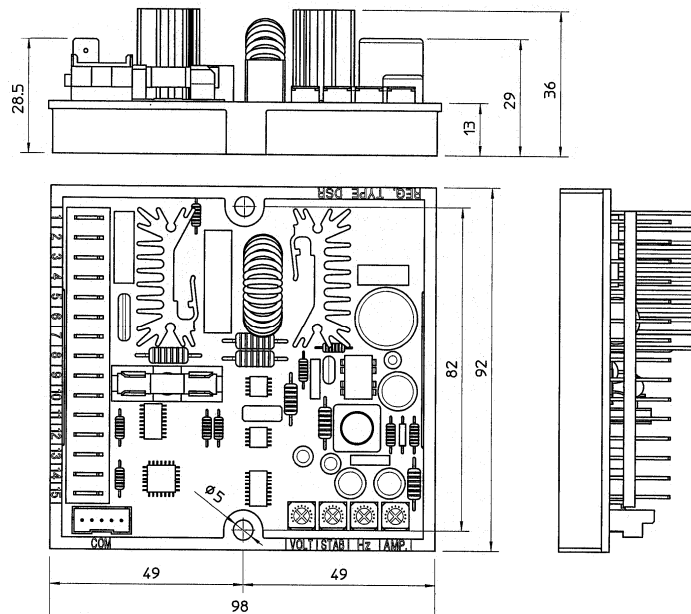

fig. 2

dimensioni in mm

## 2. Connections

The digital regulator connections depend on the application and excitation system.

Figure 1 shows the functional aspect of the connection points to the regulator.



An error in connection may have serious consequences for the unit. Carefully check to make sure that all connections are precise and in accordance with the attached drawings, before turning on the power.

## 3. Terminals

Figures 2 show the connection terminals; the connections must be made using cables having a minimum diameter :

- for power cables on terminals 1, 2, 3 and 9 (Exc-, Aux/exc+, Aux): **1,5 mm<sup>2</sup>**
- for signal cables: **0,5 mm<sup>2</sup>**

## 4. DSR connections for typical applications

Drawings SCC0059/02, SCC0060/02, SCC0061/02, SCC0062/02, SCC0063/02, SCC0064/02 show DSR regulator connections for typical applications.

Drawing SCC0059/02 shows the connection to Series 3 alternators with 6 terminals.

Drawing SCC0060/02 shows the connection to Series 3 alternators with 12 terminals.

Drawing SCC0061/02 shows the connection to alternators with 6 terminals with reference from 140V to 280V. Drawing SCC0062/02 shows the connection to alternators with 12 terminals, with reference to the half phase from 70V to 140V (for example series ECO28-38, ECO40-1S, ECO40-2S, ECO40-1L, ECO40-2L and ECO40VL)

Drawing SCC0063/02 shows the connection to alternators with 12 terminals, in series star connection or series delta connection, with reference to the entire phase from 140V to 280V (for example series ECO28-38, ECO40-1S, ECO40-2S ECO40-1L, ECO40-2L and ECO40VL)

Drawing SCC0064/02 shows the connection to alternators with 12 terminals, with reference to the half phase from 140V to 280V (for example ECO40-3S, ECO40-1,5L, Series ECO43-46)

## 5. Setting up the regulator

Selection of the sensing scale takes place directly according to the connection on the power terminal board; additional settings can be made with 4 trimmers (VOLT, STAB, AMP and Hz) and 3 jumpers (50/60Hz, JP1 and JP2); the output voltage can also be set with an external analogical or numeric signal; additional settings, can be made by modifying the 23 parameters stored in a non volatile integrated memory.

### 5.1 Alternator voltage signals

Terminals 4, 5, 6, 7 and 8 of connector CN1 are used for voltage sensing.

### 5.2 Calibrating sensing

A supplementary calibration may be necessary to compensate for any existing tolerances on analogical voltage acquisition channels; in this case follow the procedure illustrated below:

1. Write **16384** on location 19
2. Disable the Trimmers (from the **Configuration Menu**)
3. Disable Vext (from the **Configuration Menu**)
4. Set the adjustment on the average or effective value (from the **Configuration Menu**)
5. Measure the voltage with a suitable instrument for the type of adjustment made (average value or rms value)
6. Set the value at location 5 (or 6) until the voltage value, measured with the instrument, reaches 210 V (if the sensing is connected to terminals 4 or 5) or 105V (if the sensing is connected to terminals 6 or 7), keeping in mind that an increase in the value set provokes an increase in adjusted voltage and viceversa.
7. In order to ensure that the value of voltage (available also at location 36) is the same as the value measured at point 6, calibrate the data at location 7, reading the value in the first "STATUS" box (ref. DSR Terminal Software).
8. Enable the trimmers you want to be active (from the **Configuration Menu**)
9. Enable Vext (from the **Configuration Menu**) if you want to be active

### 5.3 50/60 Signal

A jumper is located on the 50/60 input (connector CN1, terminals 12 and 13); if enabled from the **Configuration Menu**, it provokes the commutation of the underspeed protection threshold from 50·(100%-αHz%) to 60·(100%-αHz%), where αHz% represents the position relative to the Hz trimmer or the percentage value entered in location 21 (where 10% corresponds to 16384).

Instruction Manual DSR digital regulator - rev. 05 - pag. 6

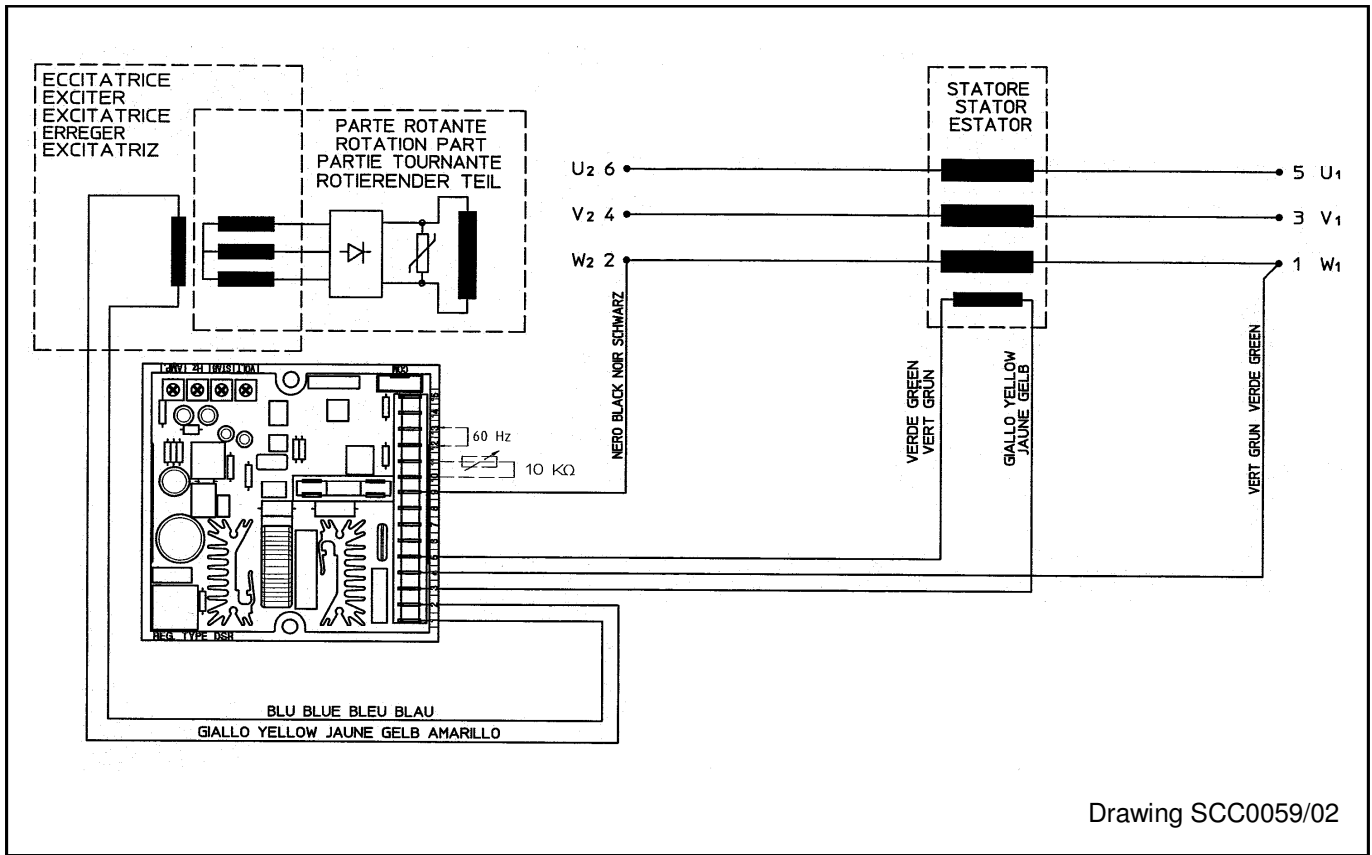

Drawing SCC0059/02

Series 3 alternators with 6 terminals  
Reference from 140V to 280V

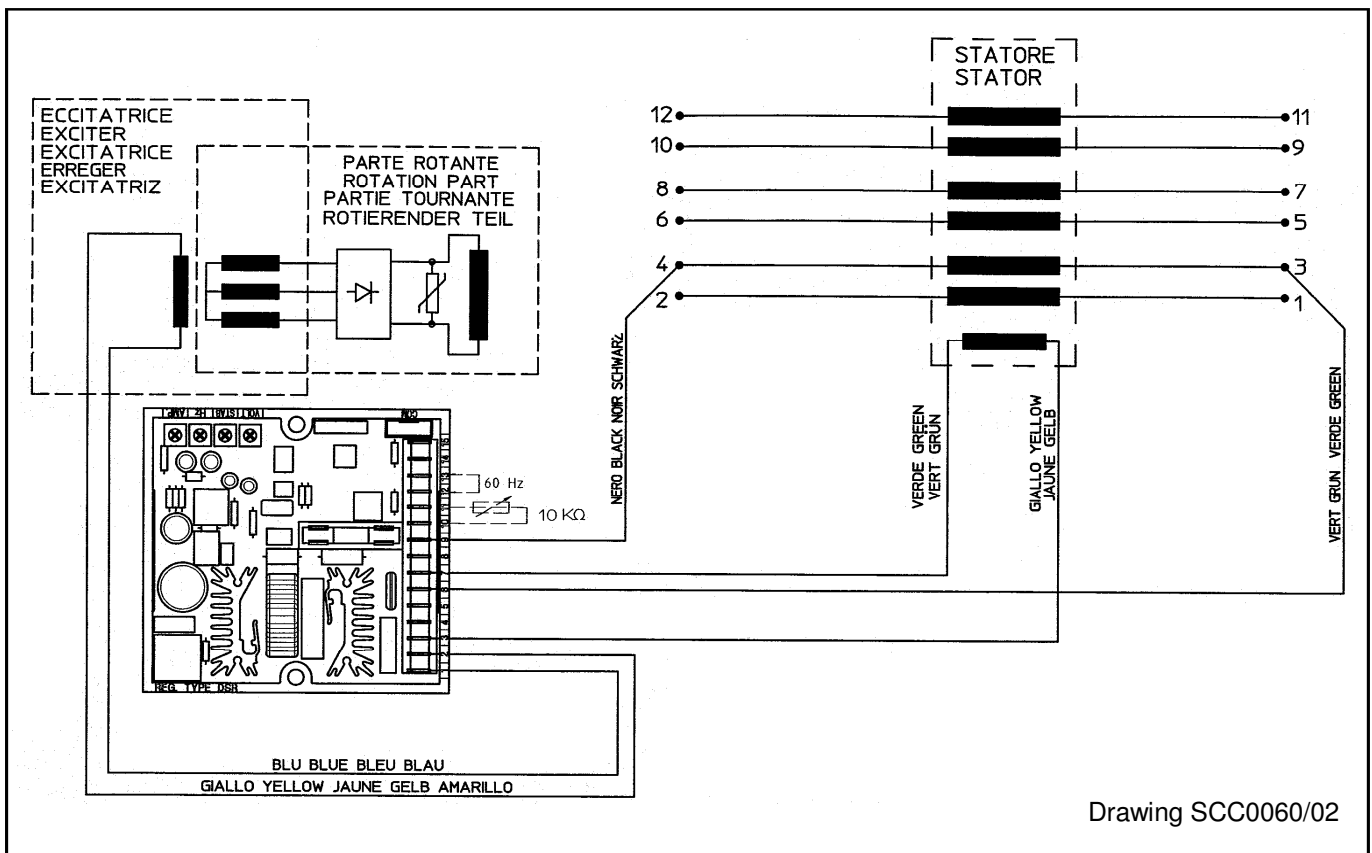

Drawing SCC0060/02

Series 3 alternators with 12 terminals  
Reference from 70V to 140V

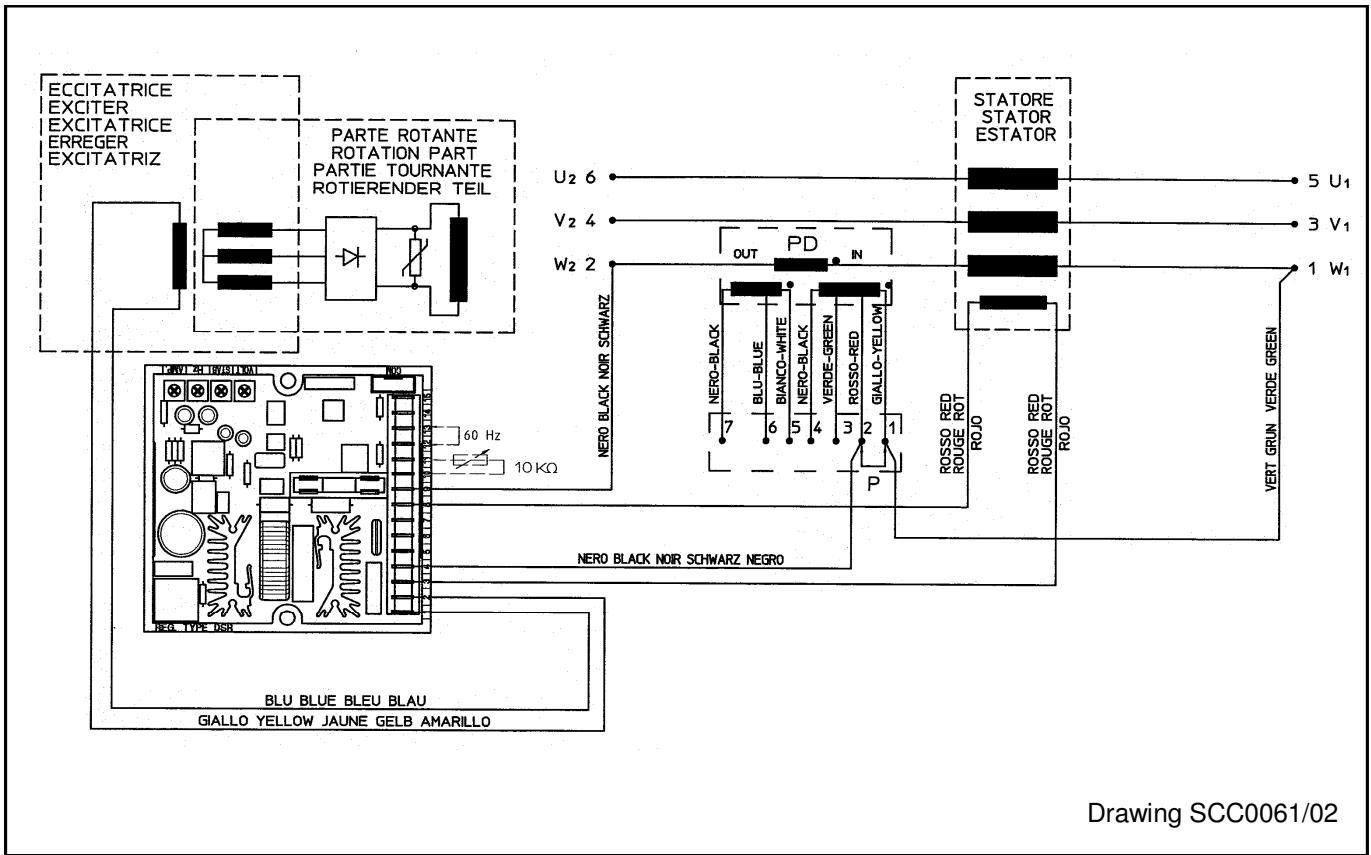

Series ECO alternators with 6 terminals  
Reference from 140V to 280V

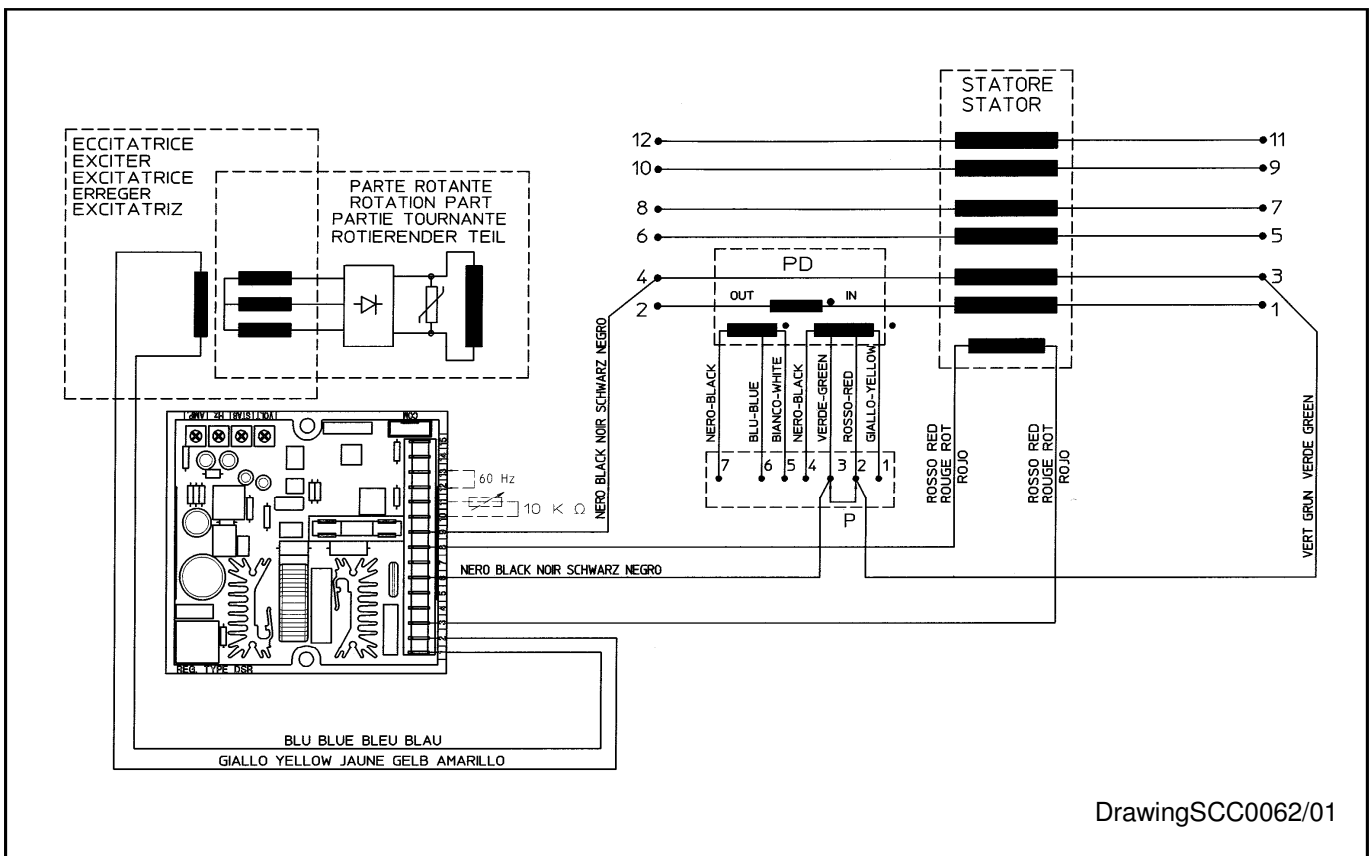

Alternators with 12 terminals, with reference on half phase, from 70V to 140V



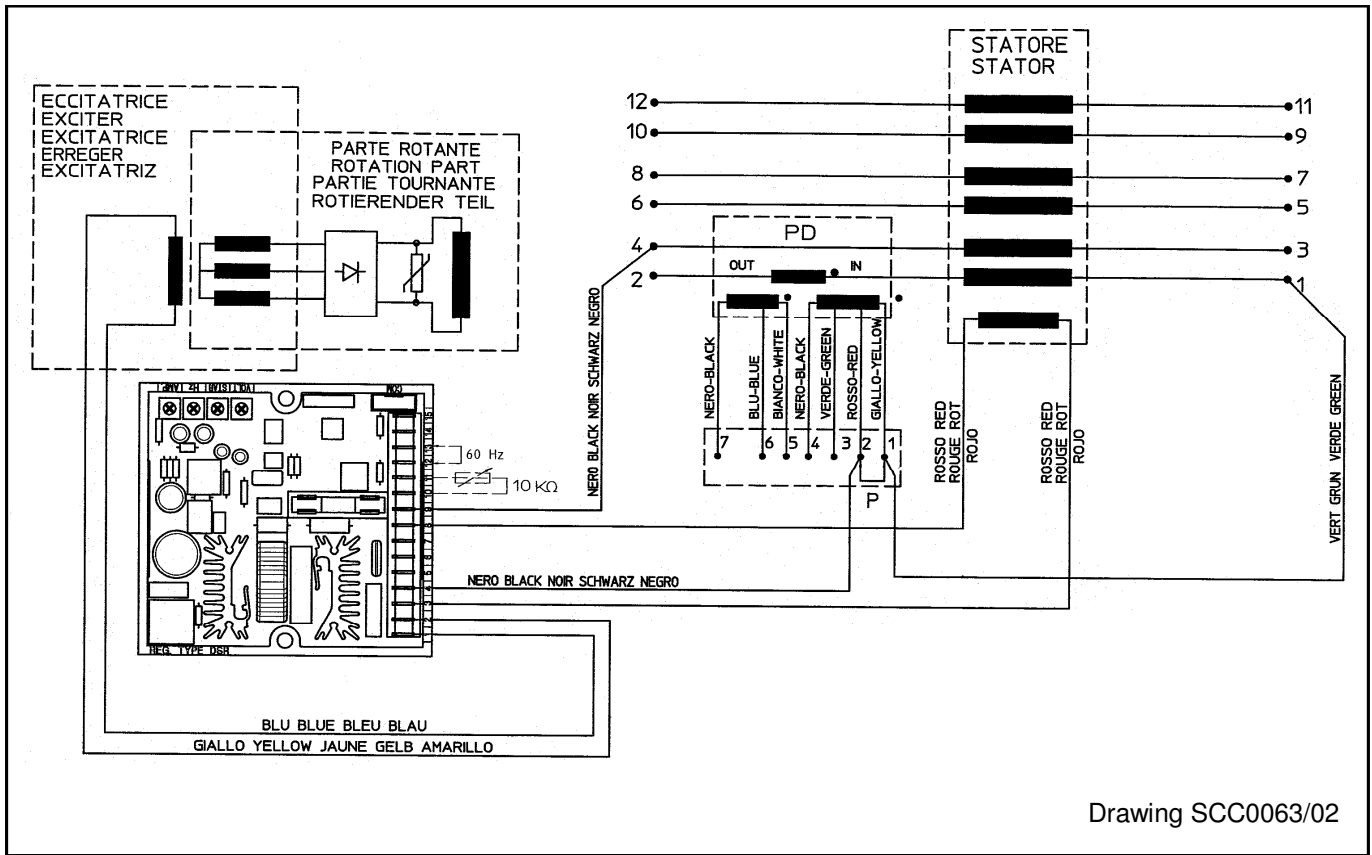

Alternators with 12 terminals, with reference on entire phase from 140V to 280V

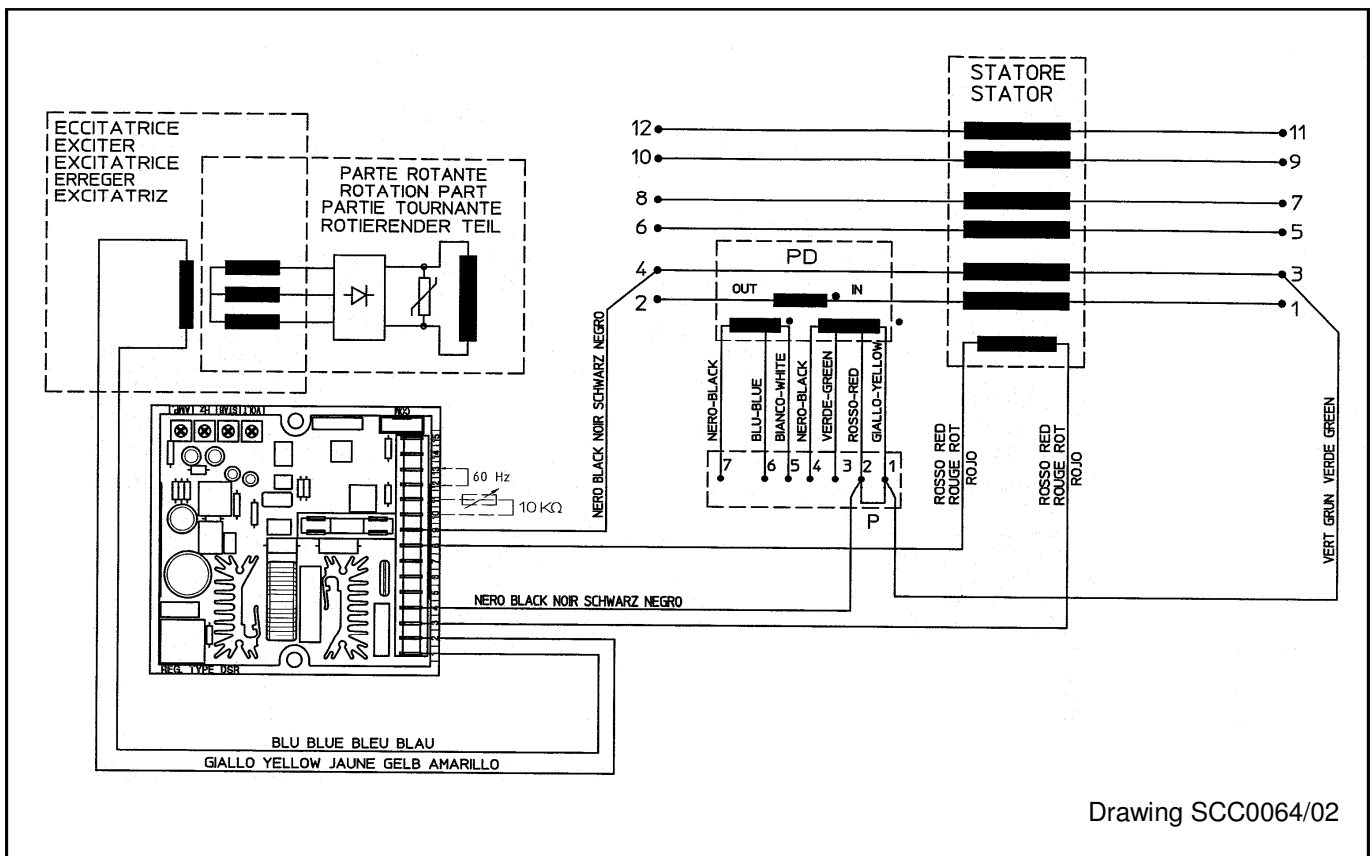

Alternators 12 terminals, with reference on half phase from 140V to 280V

## 6. Serial communications

The DI1 communications module (which is provided for connection to the COM connector of the DSR) is equipped with a RS232 port and a RS485 port, through which it is possible to set the parameters (for both configuration and operation) and monitor operation of the generator.

## 7. APO Contact

The acronym **APO** stands for **Active Protection Output**: (connector CN1 – terminals 14 and 15) 30V-100mA non-insulated open collector transistor, normally opened, is closed (with a delay that can be programmed from 1 to 15 seconds) when, among all the alarms, one or more of the active ones can be selected separately.

## 8. VOLT, STAB, Hz and AMP Trimmers

The trimmers are enabled by the software from the **Configuration** Menu; if they are not enabled, they DO NOT perform any function.

The **VOLT** trimmer allows adjustment from about 70V to about 140V or from about 140V to about 280V.

The **STAB** trimmer adjusts the dynamic response (statism) of the alternator under transient conditions.

The **Hz** trimmer allows a variation up to - 20% with respect to the nominal speed value set by jumper 50/60 (if it is active) or from box 50/60 of the **Configuration** Menu (at 50 Hz the threshold can be calibrated from 40 Hz to 50 Hz, at 60 Hz the threshold can be calibrated from 48 Hz to 60 Hz).

The **AMP** trimmer adjusts the excitation overcurrent protection intervention threshold.

## 9. Vext Input

The Vext input (connector CN1 – terminals 10 and 11) permits analogical remote control of output voltage through a 10Kohm potentiometer with a programmable variation range through parameter 16 with respect to the value set (by default the setting is  $\pm 14\%$  starting from revision 10 of the Firmware); if you want to use continuous voltage, it will be effective if it is in the range between 0V and +2,5V. The input tolerates voltages from -5V to +5V, but for values exceeding the limits of 0V / +2,5V (or in the event of disconnection), two options are possible: not to take the set point of external input (default configuration) and return to regulation to the voltage value set with the trimmer (if enabled) or with parameter P[19], or keep the minimum (or maximum) value of voltage that can be reached (see figures 3a and 3b). The two options can be set with the **RAM Voltage CTRL** flag in the **configuration** menu corresponding to the bit B7 of the configuration word P[10] (see PARAMETERS AND OPERATIONAL DATA - Para. 2). The setting relative to the Vext input are summarised in table 5.

**NOTE:** the source of DC voltage must be capable of absorbing at least 2 mA.

In making adjustments it is recommended not to exceed the nominal value of voltage of the alternator beyond  $\pm 10\%$ .

### Relationship between analogical input (Vext) and output voltage (Vo)

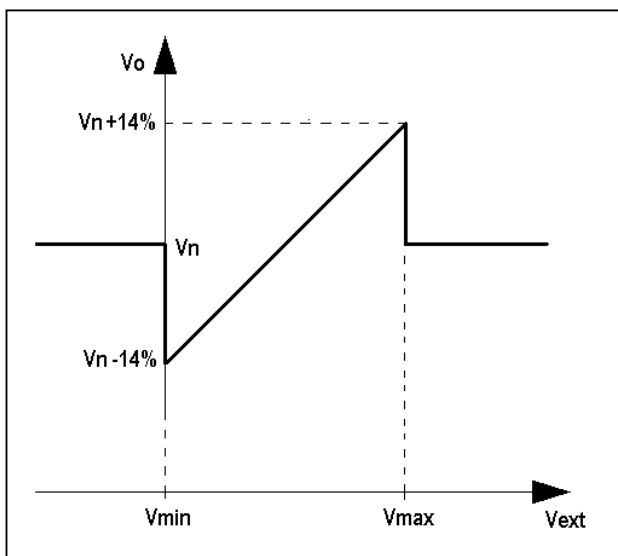

Figure 3a: without saturation of the output voltage upon reaching the input voltage limits

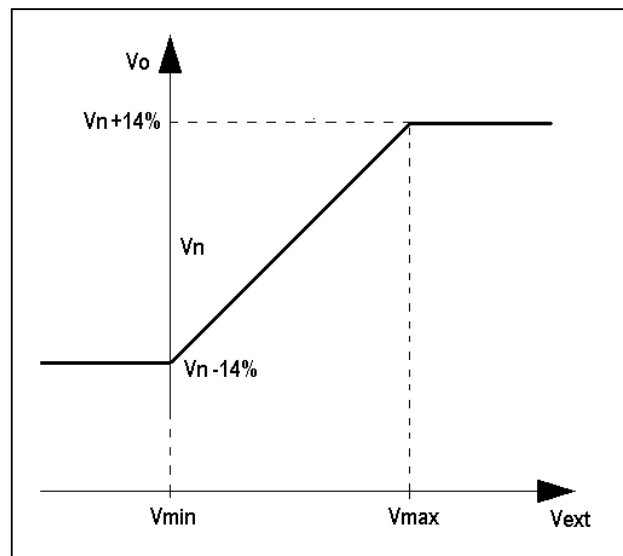

Figure 3b: with saturation of the output voltage upon reaching the input voltage limits

## SERIAL CONNECTION

The COM connector is RESERVED for connection to the DI1 communications module with the special cable provided with the module itself.

The serial interface of the DI1 communications unit is of the RS232 or RS485 type: it will therefore be possible to connect several DSR-DI1 groups as well (and therefore several generators) in parallel on the same 485 Bus, in order to monitor the operation with a single supervising unit. The regulator implements a sub-system of the MODBUS standard for communications; the DI1-DSR set performs slave operation, whose address is memorised in the EEPROM and is set during the phase of configuration.

When necessary, the DI1 interface permits insertion of the regulator in a RS485 network with other regulators or other devices of a different type, but with the same type of bus. Detailed descriptions of the Mod-Bus commands implemented are into the Technical Guide "Digital Regulators Communication Protocol" available on the web site [www.meccalte.com](http://www.meccalte.com)

The "Master Unit" is made up of a PC or other dedicated equipment and can access the parameters and functions of the regulator.

The master unit has the following possible functions:

- Repetition, or visualisation, of the generator status variables, even from a remote location
- Setting of single parameters
- Uploading and downloading of settings files
- Status readings (alarms, measuring variables)
- Readings of the alarm memory information
- Interface conversion towards other field buses or communications networks.

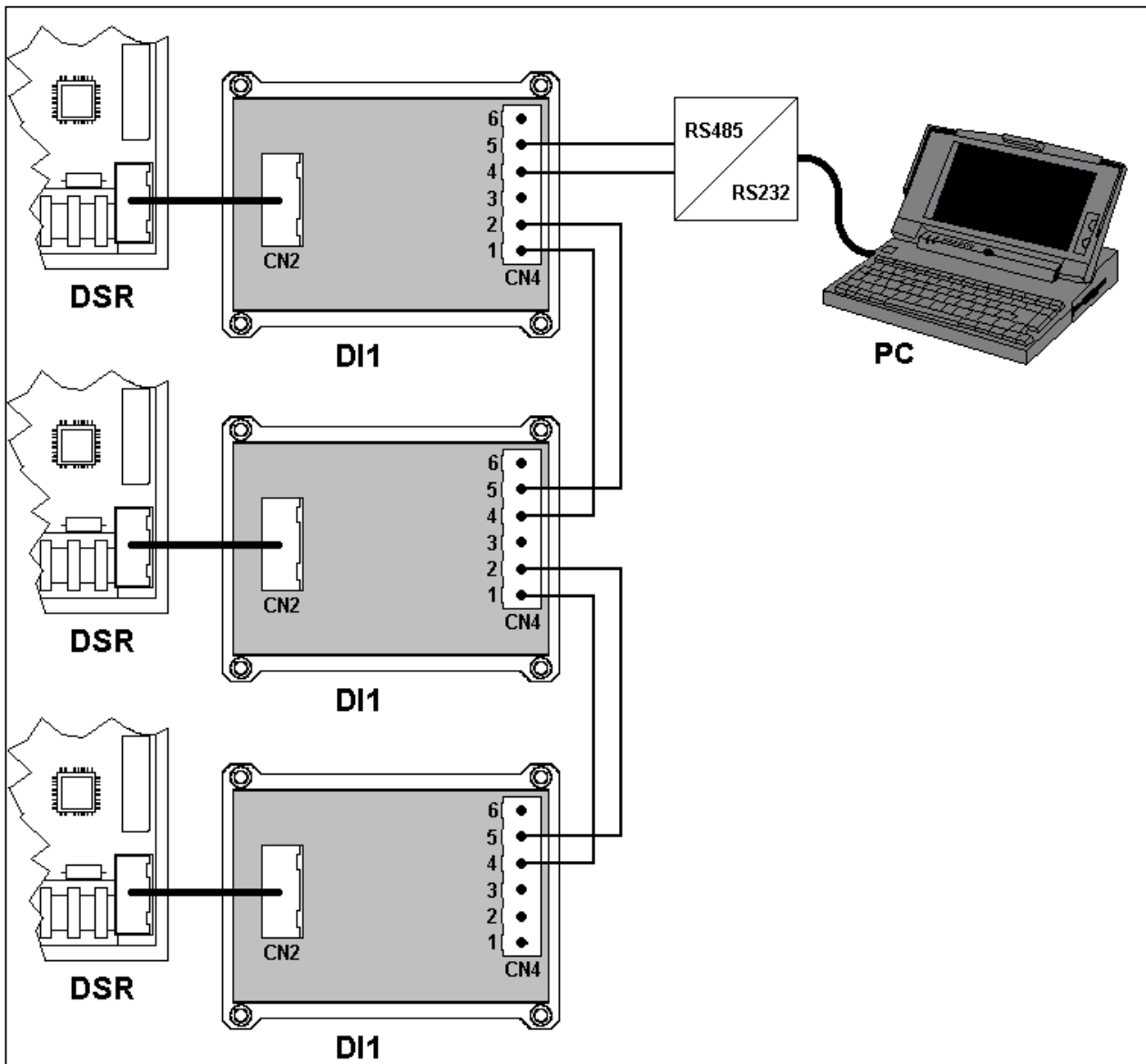

Fig. 4: R485 connection between DSR regulators and PC, through DI1 digital interface

## PARAMETERS AND OPERATING DATA

### 1. ModBus Registry List

An EEPROM memory is used to store configuration parameters and other information that must not be lost when the generator goes off. Parameters can be read/written and machine operational settings entered through serial connections. Two versions of this regulator are available: DSR and DSR/A; they differ mainly in the default parameters. Table 3 shows a complete list of the parameters that can be set, which define all the operational conditions of the regulator.

**TABLE 3 : EEPROM SETTING REGISTRIES**

Add.	Description of Parameter	Range	Default		NOTES
			DSR	DSR/A <sup>(1)</sup>	
0	Firmware revision	0..65535	15	15	Reserved - Do not write
1	ModBus slave address	1..31	1	1	Identification of RS485 network (or broadcast)
2	Software configuration	0..65535	18	2706 <sup>(2)</sup>	Reserved - Do not write
3	Serial number, high part	16bit	0	0	Reserved - Do not write
4	Serial number, low part	16bit	0	0	Reserved - Do not write
5	RMS sensing calibration	0..32767	16384	16384	Calibration of voltage channels in 3 ph adjustment
6	AVG sensing calibration	0..32767	16384	16384	Calibration of voltage channels in 1 ph adjustment
7	Measured voltage calibration	0..32767	16384	16384	Calibration of location L 36 (first "STATUS" box)
8	Current limit time <sup>(3)</sup>	0..32767	0	0	Duration of limiting in number of periods <sup>(3)</sup>
9	Current limit level <sup>(3)</sup>	0..32767	32767	32767	Excitation voltage limit upon start-up <sup>(3)</sup>
10	Word configuration	16bit	7965	7965	Set from "Configuration" Menu", see Tab. 7
11	Shift to LEFT proportional gain	0.6	4	5	n=0...6 is equivalent to a multiplication by 2 <sup>n</sup>
12	Shift to LEFT integral gain	0.6	3	1	
13	Coefficient tying Ki to Kp	0..32767	16384	26624	Coefficient to set Ki and Kp separately
14	Vout / Vaux Ratio	±32767	6000	6000	Limit to voltage reduction as a function of frequency
15	Reference equivalent to Vext	0..32767	16384	16384	Value used if the Vext input and location L[49] are disabled <sup>(2)</sup>
16	Limitation of Vext Variation	0..3277	4608	4608	Limits the effect of external analogical input (0->0; 3277->10%)
17	APO delay & alarm settings	0..65535	126	126	Selects alarms that activate the APO contact and sets the delay intervention
18	Step limitation reference	1..1000	20	20	For rapid variations of voltage setpoint, the passage from one value to another takes place through added or subtracted steps at each period.
19	Vout Reference	0..32767	0	0	Value used if the VOLT trimmer is disabled
20	Stability	0..32767	16384	16384	Value used if the STAB trimmer is disabled
21	Freq. threshold ± 10% freq <sub>nom</sub>	0..32767	16384	16384	Value used if the Hz trimmer is disabled
22	Excitation overcurrent threshold	0..32767	16384	16384	Value used if the AMP trimmer is disabled
23	V/F Slope	0..32767	9000	9000	V/F curve slope during normal operation
24	V/F curve slope at start up	0..32767	12000	12000	Used only upon start up
25	Short circuit time	0..255	20	20	Operating time with short circuited alternator, expressed in tenths of seconds (0 ..... 25.5 seconds) [0=excluding STOP]
26	Overspeed threshold	±32767	0	0	Variation (±10%) of overspeed alarm intervention with respect to the default value of 55/66Hz
27	Shutdown threshold	0..32767	6553	6553	Reserved - Do not write
28	Ki over-excitement Regulator	0..32767	12287	12287	Integral and proportional gain of excitation voltage regulator
29	Kp over-excitement Regulator	0..32767	24575	24575	
30	Thermal dispersion coefficient	0..65535	63600	63600	Used by AMP alarm temperature estimator
31	Reserved	0..65535	-	-	Do not write

NOTE: Locations are ordered to separate the parameters of individual regulators (S.N., SW versions and calibration) from settings foreseen, in order to facilitate programming of regulators with the same settings but different S.N., SW versions and calibrations. The parameters from 0 to 9 are adjusted at the factory for each regulator. The parameters from 10 to 30 can therefore be freely copied from one to another.

NOTE (1) starting from rev.10 of the Firmware

NOTE (2) starting from rev.15 of the Firmware, 2578 in previous versions

NOTE (3) starting from rev.15 of the Firmware

## 2. Configuration word (Parameter P[10])

Configuration of the regulator takes place by setting the individual bits of parameter P[10]. Each of them enables or disables at least one function, on the basis of the fact that its value is respectively 1 or 0. If the "DSR Terminal" programme is used (see the Chapter on "Use of DSR Terminal monitoring and programming software"), the setting is facilitated with the *Configuration* menu, where each box enables or disables a function and corresponds to the respective bit.

Alternatively, the DSR can be configured by directly setting the value of the P[10] parameter; in this case the value is calculated before entry, summing the numbers indicated in the column "Value" of Table 4, corresponding to the functions it is desired to enable.

For example, the default configuration calls for the bits B0, B2, B3, B4 and those from B8 to B12 to be enabled. The corresponding value is therefore:  $P[10]=1+4+8+16+256+512+1024+2048+4096=7965$ .

TABLE 4 : BIT FUNCTION OF THE CONFIGURATION WORD (PARAMETER P[10] )				
Bit	Value	Function		Default
B0	1	RMS regulation		1
B1	2	Periodical reference variation		0
B2	4	Automatic voltage offset compensation		1
B3	8	Voltage measurement by last 32 samples		1
B4	16	Enable hardware jumper 50/60Hz		1
B5	32	Free for future use		0
B6	64	Not used		0
B7	128	External location reference L[49] <sup>(1)</sup> and activation of saturation in the event of overflow <sup>(2)</sup>		0
B8	256	Enable VOLT TRIMMER		1
B9	512	Enable STAB TRIMMER		1
B10	1024	Enable Hz TRIMMER		1
B11	2048	Enable AMP TRIMMER		1
B12	4096	Enable external analogical input		1
B13	8192	Enable external DAC		0
B14	16384	60 Hz setting in the event of disabling of the 50/50 Hz hardware jumper		0
B15	32768	Reserved		0

NOTE (1): if analogical input is disabled, starting from rev.15 of the Firmware

NOTE (2): for analogical input, starting from rev.15 of the Firmware

## 3. RAM location reference, activation of saturation in analogical remote control

The RAM Voltage CTRL Flag (corresponding to bit 7 of the P[10] configuration word) performs two functions:

1. If the Pext hardware input is enabled (Flat Ext. Input corresponding to bit 12 of the P[10] configuration word), the **RAM Voltage CTRL Flag** activates saturation of output voltage when the analogical control voltage reaches the limit foreseen for input, to which it is applied (see Para. 8 Remote control of voltage).



If saturation is enabled, in the event of removal of the Vext/Pext connection (due to accidental opening, for example) the voltage goes to the maximum value set in parameter P[16] (+14% by default).

2. When hardware input Pext is disabled, the indicated flag defines the value to be used by the software control of the output voltage. If **RAM Voltage CTRL** is deactivated (B7=0), the non volatile parameter P[15] is used (therefore following shut down and restart of the regulator, the last value memorised remains set): on the start up the location L[49] is initialised with the value of parameter P[15] and is kept aligned to that value. Editing of location L[49] has no effect in this working condition. If **RAM Voltage CTRL** is active (B7=1) the volatile location L[49] is used for software remote control of the output voltage (when the regulator is energized, the value is stored; if the regulator is shut down, the value is lost). This function is particularly useful for the applications of alternators in parallel with grid, when the regulation of the reactive power exchanged is controlled by means of a third party supplied digital supervisor.

TABLE 5 : REMOTE VOLTAGE CONTROL FLAGS FUNCTION				
FLAG RAM Voltage CTRL	P[10] Bit B7	FLAG Ext. Input	P[10] Bit B12	Output voltage control type
<input type="checkbox"/>	0	✓	1	Analogical without saturation
✓	1	✓	1	Analogical with saturation
<input type="checkbox"/>	0	<input type="checkbox"/>	0	Digital - Parameter P[15]
✓	1	<input type="checkbox"/>	0	Digital - Location L[49]

#### 4. Volatile memory addresses

TABLE 6 : VOLATILE MEMORY ADDRESSES				
Addr.	Add name	Range	Access	Description
32	VOLT Trimmer	0..32767	Read only	VOLT Trimmer Position
33	STAB Trimmer	0..32767	Read only	STAB Trimmer Position
34	Hz Trimmer	0..32767	Read only	Hz Trimmer Position
35	AMP Trimmer	0..32767	Read only	AMP Trimmer Position
36	First status word	0..3200	Read only	Regulated voltage [tenths of volts]
37	Second status word	0..900	Read only	Frequency [tenths of Hz]
38	Third status word	16bit	Read only	Active alarms
39	Fourth status word	16bit	Read only	Active configuration
40	Commands	16bit	Write	Reserved Word Commands – Do not use
41	Pext/Vext Inputs	0..32767	Read only	Analogical input or external potentiometer value
42	Setpoint	0..32767	Read only	Setpoint value
43	Setpoint	0..32767	Read only	Value modified by regulator in case of alarms, soft-start, etc.
44	Measured Voltage	0..32767	Read only	Internal variable
45	Estimated temperture	0..32767	Read only	Estimates temperature of exciter windings
...	...			...
49	Reference corresponding to Vext	0..32767	Write	Used if Vext input is disabled and voltage remote control by RAM location is enabled (P[10]-Bit B7=1)
...	...			...
53	$Kp/2^{P[11]}$	0..32767	Read only	Proportional gain not considering factor $2^{P[11]}$ (1)
54	$Ki/2^{P[12]}$	0..32767	Read only	Integral gain not considering factor $2^{P[12]}$ (1)
55	AMP protection threshold	0..32767	Read only	Intervention threshold of overexcitation protection (1)
...	...	0..32767		...

#### 5. Fourth Status Word (Location L[39])

Location L[39] indicates (almost in real time) the active configuration at any given time.

The values of the fourth word of status (location L[39]) are shown in table 7, on the basis of the most common types of sensing and nominal frequency.

TABLE 7 : STANDARD VALUES OF THE FOURTH STATUS WORD (LOCATION L[39])		
Regulation	Rated frequency:	
	50Hz	60Hz
RMS	7965	24349
AVG + no offset compensation + 64 samples	7952	24336

TABLE 8 : BIT FUNCTION OF THE FOURTH STATUS WORD L[39] (ACTIVE CONFIGURATION)			
Bit	Function	Value	Default
B0	Active RMS Regulation	1	1
B1	Bit activating a periodical variation of reference voltage	2	0
B2	Bit activating automatic compensation of the offset in voltage acquisition channels	4	1
B3	Voltage measurement by last 32 samples	8	1
B4	Bit enabling reading of 50/60 Hz jumper hardware	16	1
B5	Free for future use	32	0
B6	Not used	64	0
B7	Voltage remote control by RAM location L[49] or input saturation ( in case of overflow ) (1)	128	0
B8	Bit enabling reading of reference voltage by VOLT Trimmer	256	1
B9	Bit enabling reading of stability parameter by STAB Trimmer	512	1
B10	Bit enabling reading of underspeed protection threshold by Hz Trimmer	1024	1
B11	Bit enabling reading of excitation current threshold by AMP Trimmer	2048	1
B12	Bit enabling reading of external voltage input	4096	1
B13	Bit enabling DAC	8192	0
B14	60Hz active setting (jumper 60Hz closed and/or 60Hz active setting on configuration menu)	16384	0/1
B15	Reserved	32768	0

NOTE (1) : starting from rev.15 of the Firmware.

## IMPOSTAZIONE DEI PARAMETRI VOLT, STAB, AMP Hz.

### 1. Voltage

#### 1.1 Setting voltage

Measurement of the rms or average value is decided from the **Configuration** Menu.

The voltage setting may take place through the trimmer or software; the sensing input range on CN1-6 and CN1-7 is 70÷140 Vac; the sensing input range on CN1-4 and CN1-5 is 140÷280 Vac.

There are two ways to set the value from the minimum to the maximum:

1. Through the VOLT trimmer, which must be enabled from the Configuration Menu.
2. Through parameter 19 (the Volt trimmer must be disabled from the Configuration Menu: A value of 0 corresponds to minimum voltage, 16384 corresponds to the intermediate value (respectively, 105V and 210V), while 32767 corresponds to the maximum voltage.

For standard voltage values refer to table 9.

Voltage CN1 4&5	Voltage CN1 6&7	Volt Trimmer (Location 32)	Parameter 19
173	-	7724	7724
-	127	26683	26683
200	100	14043	14043
208	104	15916	15916
220	110	18725	18725
230	115	21065	21065
240	120	23406	23406
266	133	29491	29491
277	138,5	32066	32066

It is possible to vary the voltage through the Vext input as well (connector CN1-10 and CN1-11), providing it has been enabled from the **Configuration** Menu, through a 10Kohm potentiometer with a programmable variation range of up to ±100% (parameter 16; the default setting is ±14%, even if it is convenient do not exceed more than ±10%), or through a continuous voltage, which will be effective if it is in the range between 0V and +2,5V, or even through parameter P [15] or location L[49] (if the Vext input is disabled). For additional details see the paragraph "Remote control of voltage".

#### 1.2 Soft Start (starting from rev.15 of the Firmware)

In the event of fast start up of the prime mover or sudden regulator switching on, with generator running at nominal speed, to guarantee the nominal voltage the excitation current should quickly change and therefore it could happen an engine braking effect or temporary generator overvoltage.

These effects can be minimised by setting parameter P[8] and P[9] appropriately. In the phase of start up, they determine a limit of the excitation current.

Parameter P[8] sets the duration of the excitation current limitation, namely the value of the parameter corresponds to the number of periods in which the limitation is active. The default value is P[8]=0 which corresponds to deactivation of the soft start. Considering that in most cases the alternator is already at nominal speed, an estimate in temporal terms may be obtained with the formula:

$$t_{lim} = P[8] \cdot \frac{1}{f_n} = P[8] \cdot \frac{30}{\omega_n} \quad \text{Where } f_n = \text{nominal frequency in Hz or } \omega_n = \text{nominal speed in R.P.M}$$

The parameter P[9] sets the excitation current limit: the value P[9]=0 corresponds to zero excitation current, while the maximum value P[9]=32767 corresponds to no limits on the current limitation. The default value is P[9]=32767. When the interval of action of the soft start has been exceeded, the output voltage moves to the value set. The rapidity of the change is set by parameter P[18] (see paragraph on "Slow voltage variations")



The optimal values of parameters P[8] and P[9] depend a great deal on the type of alternator and final application and it must be found through experimentation. An inappropriate setting of parameters P[8] and P[9] could cause failure of the alternator to excite itself.

By way of example, for high power alternators of the ECO46 series, the following settings may be experimented: P[8]=64 and P[9]=16384; for low power alternators of the ECO/ECP3 series, the effects of a reduction of both the duration and limitation of the current may be experimented, such as P[8]=16 and P[9]=4096.

## 1.2 Slow voltage variations

In the event of a reference rapid variation, due to a regulator sudden feeding, or remote voltage setting (through Vext analogic input or through serial) a procedure of "slow" variation has been foreseen: in response to a step variation, parameter P[18] determines the rapidity with which the transition is made. (see fig. 5)

A value of 1 involves the slowest possible variation; a value exceeding 100 involves an almost immediate variation. The value 0 disables any variation.

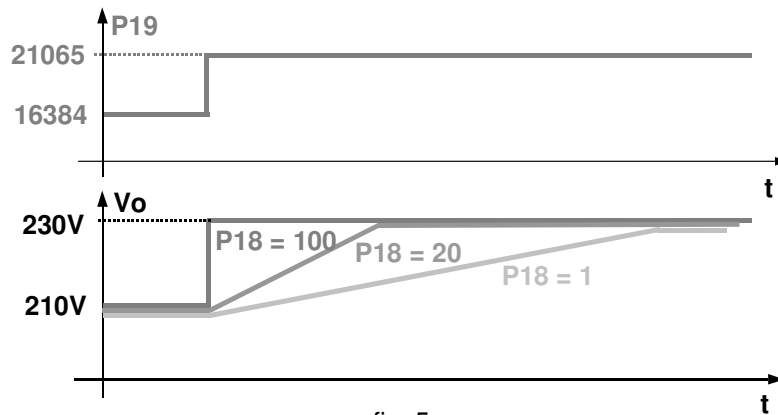

fig. 5

## 2. Stability

### 2.1 Stability regulation

The voltage regulator is of the proportional-integral type, the diagram is shown in fig. 6.

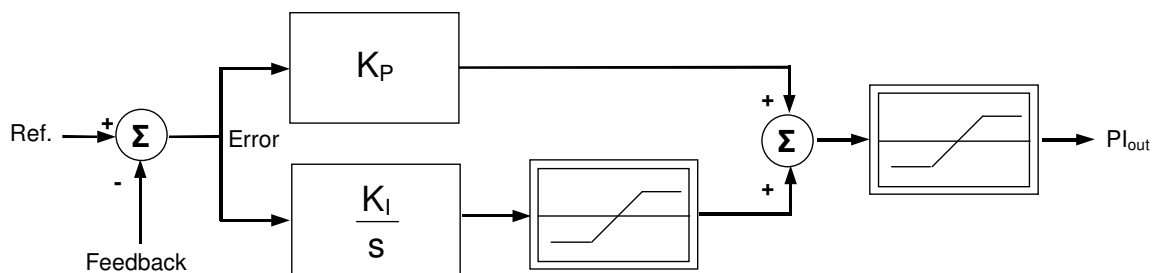

fig. 6: regulator diagram

The values of the proportional and integral gain ( $K_P$  and  $K_I$  respectively) depend on the position of the STAB trimmer if enabled, or the value of parameter P[20] if the trimmer is disabled. The value of the proportional gain  $K_P$  also depends on the value of the P[11] parameter. The value of the integral gain  $K_I$  depends on the values of parameters P[12] and P[13] and, only for the standard DSR (grey box) with the STAB trimmer enabled, even on the 50/60Hz<sup>(1)</sup> setting. In the other DSR versions, for example DSR/A (blue box), the integral gain  $K_I$  does not differ no matter how the 50/60Hz<sup>(4)</sup> setting is set.

The numeric elaborations carried out by the DSR for obtaining the proportional and integral gain values are given in the block diagrams in figures 6a<sup>(2)</sup>, 6b<sup>(2)</sup> and 6c.

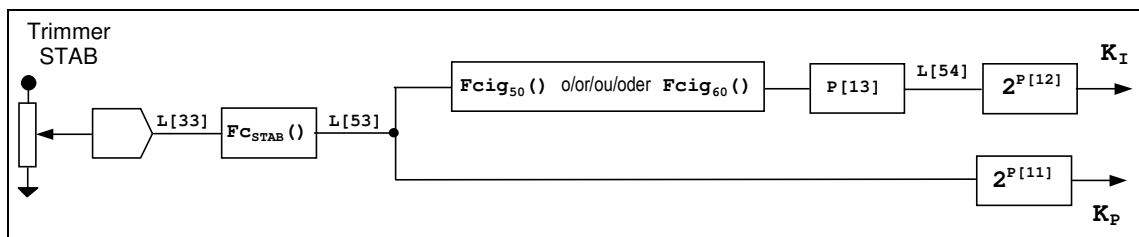

fig. 6a: drawing of the numeric elaboration of the proportional and integral gain by a DSR (standard) with the STAB trimmer enabled



If the STAB trimmer is enabled (STAB Flag Trimmer present) its angular position, available at location L[33], is transformed by the  $F_{C_{STAB}}^{(2)}$  function into the numeric value available at location L[53]<sup>(3)</sup> (figs. 6a and 6b). If the STAB trimmer is disabled, the value of location L[53]<sup>(3)</sup> directly becomes the value set using the P[20] parameter (fig. 6c).

The proportional gain  $K_P$  is obtained by multiplying the value of location L[53]<sup>(3)</sup> by a coefficient that depends on the value given in parameter P[11]<sup>(4)</sup>.

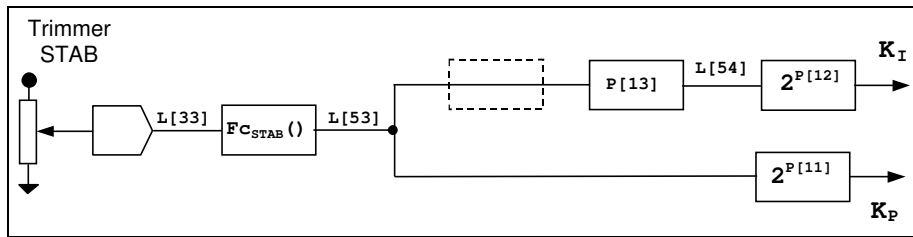

fig. 6b: drawing of the numeric elaboration of the proportional and integral gain by a DSR/A with the STAB trimmer enabled

The integral gain, available at location L[54]<sup>(3)</sup> minus the multiplication by a coefficient, depends on the value of the proportional gain at location L[53]<sup>(3)</sup>; in the standard DSR (grey box) with the STAB trimmer enabled (STAB Flag Trimmer present) the value of location L[53]<sup>(3)</sup> at 50Hz is transformed by the function  $F_{cig_{50}}^{(2)}$  and by the multiplication of the value of parameter P[13], in the numeric value available at location L[54]<sup>(3)</sup>; at 60Hz the transformation function is  $F_{cig_{60}}^{(2)}$ , different from that at 50Hz, (fig. 6a); in the other versions of the DSR (fig. 6b), for example DSR/A (blue box), or if the STAB trimmer is disabled<sup>(4)</sup> (fig. 6c), not only is there a difference between the integral value at 50Hz and at 60Hz, but even the value of location L[54]<sup>(3)</sup> is obtained by simply multiplying the proportional gain at location L[53]<sup>(3)</sup> by the value of parameter P[13].

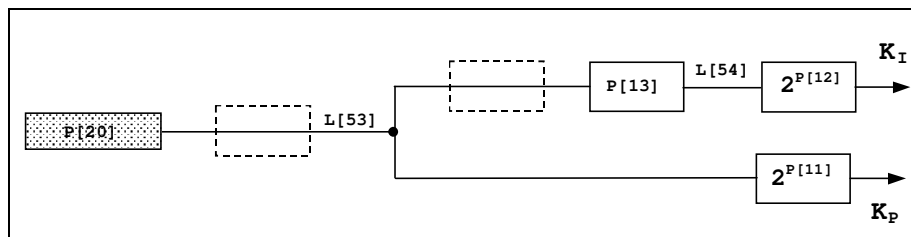

fig. 6c: drawing of the numeric elaborations of proportional and integral gain by all DSRs with STAB trimmer disabled

In both cases, the effective integral gain  $K_I$  is obtained by multiplying the value of location L[54]<sup>(3)</sup> by a coefficient that depends on the value given in parameter P[12]<sup>(4)</sup>.

The mentioned coefficients can take on values of 1, 2, 4, 8, 16, 32 or 64 according to the values written in parameters P[11] (for proportional gain) and P[12] (for integral gain); these values represent the value assigned to base 2 (fixed) to obtain the required coefficient (e.g. parameter P[11] = 4 => multiplication coefficient of the proportional gain =  $2^4 = 16$ , P[12] = 3 => multiplication coefficient of the integral gain =  $2^3 = 8$ ).

The following tables, for each 50Hz and 60Hz machine, show the setting of the STAB trimmer that gives the best answer speed to the transient with the gen-set in single operation. In the case of different applications (for example alternators in parallel or in parallel with grid, motors with less than 4 cylinders, etc.) it may be necessary to modify the settings of the STAB trimmer. If the voltage cannot be stably adjusted for permanent operation and/or in the transients by the STAB trimmer settings, it may be necessary to vary one or more stability adjustment parameters: P[11], P[12] and P[13] the description of which is given in table 3.

NOTE (1) Starting from Rev. 15 of the firmware

NOTE (2) The  $F_{C_{STAB}}$ ,  $F_{cig_{50}}$  and  $F_{cig_{60}}$  functions are not implemented in the DSRs with firmware up to version 14, and in the block diagram they are considered as identities, i.e.  $L[53]^{(3)} = F_{C_{STAB}}(L[33]) = L[33]$  e  $F_{cig_{60}}(L[53]) = F_{cig_{50}}(L[53]) = L[53]^{(3)}$ .  
With these regulators the STAB trimmer needs to be rotated by less than two notches counted clockwise.

NOTE (3) Location available to the user from firmware Rev. 15.

NOTE (4) Structure valid also for DSRs with firmware up to version 14 but without location L[53] and L[54] availability

**TABLE 10 ECO/ECP SERIES: ADVISED STAB TRIMMER SETTING ON DSR<sup>(1)</sup> Fw Rel. 15**

Generator		115/200/230/400V 50Hz				138/240/277/480V 60Hz			
Type	Poles	S [KVA]	STAB	L[33]	L[53]	S [KVA]	STAB	L[33]	L[53]
ECP3-1SN/2	2	8	5	12480	4753	9,6	4	8576	2245
ECP3-2SN/2	2	10	5	12480	4753	12	4½	10559	3403
ECP3-3SN/2	2	12,5	5	12480	4753	15	4½	10559	3403
ECP3-1LN/2	2	16	5½	14400	6328	19,2	5	12480	4753
ECP3-2LN/2	2	19	5½	14400	6328	22,8	5	12480	4753
ECO28-1LN/2	2	22	6½	18368	10296	26,4	n.a.	n.a.	n.a.
ECO28-2LN/2	2	27	5½	14400	6328	32,4	5½	14400	6328
ECO28-3LN/2	2	31,5	5	12480	4753	37,8	n.a.	n.a.	n.a.
ECO28-VL/2	2	40	7½	22208	15051	48	6	16384	8192
ECO31-2SN/2	2	44	n.a.	n.a.	n.a.	52,8	n.a.	n.a.	n.a.
ECO31-3SN/2	2	55	n.a.	n.a.	n.a.	66	n.a.	n.a.	n.a.
ECO31-1LN/2	2	66	n.a.	n.a.	n.a.	79,2	5	12480	4753
ECO31-2LN/2	2	82	n.a.	n.a.	n.a.	98,4	n.a.	n.a.	n.a.
ECO3-1SN/4	4	6,5	6	16384	8192	7,8	6	16384	8192
ECO3-2SN/4	4	8	5½	14400	6328	9,6	4½	10559	3403
ECO3-1LN/4	4	11	5	12480	4753	13,2	4½	10559	3403
ECO3-2LN/4	4	13,5	6	16384	8192	16,2	5½	14400	6328
ECO3-3LN/4	4	15	6½ <sup>(2)</sup>	18368 <sup>(2)</sup>	10296 <sup>(2)</sup>	18	5½	14400	6328
ECO28-1VS/4	4	7,8	5	12480	4753	9,3	4	8576	2244
ECO28-2VS/4	4	11	4	8576	2244	13,2	4	8576	2244
ECO28-OS/4	4	13,5	5½	14400	6328	16,2	5	12480	4753
ECO28-SN/4	4	17	6	16384	8192	20,4	5½	14400	6328
ECO28-1LN/4	4	20	5½	14400	6328	24	5	12480	4753
ECO28-2LN/4	4	25	7	20288	12561	30	5	12480	4753
ECO28-VL/4	4	30	7 <sup>(3)</sup>	20288 <sup>(3)</sup>	12561 <sup>(3)</sup>	36	6 <sup>(3)</sup>	16384 <sup>(3)</sup>	8192 <sup>(3)</sup>
ECO32-2S/4	4	35	5½	14400	6328	42	4½	10559	3403
ECO32-3S/4	4	40	6	16384	8192	48	6	16384	8192
ECO32-1L/4	4	50	7½	22208	15051	60	4	8576	2244
ECO32-2L/4	4	60	8	24191	17860	72	5½	14400	6328
ECO32-3L/4	4	70	8½	26176	20908	84	5½	14400	6328
ECP34-1S/4	4	85	7½	22208	15051	102	7	20288	12561
ECP34-2S/4	4	105	6½	18368	10296	126	6½	18368	10296
ECP34-1L/4	4	130	8½	26176	20908	156	6½	18368	10296
ECP34-2L/4	4	150	8½	26176	20908	180	8	24191	17860
ECO38-1SN/4	4	180	9	28096	24090	216	6½	18368	10296
ECO38-2SN/4	4	200	9	28096	24090	240	8	24191	17860
ECO38-3SN/4	4	225	8½	26176	20908	270	7½	22208	15051
ECO38-1LN/4	4	250	8½	26176	20908	300	8	24191	17860
ECO38-2LN/4	4	300	8	24191	17860	360	<b>max</b>	<b>32704</b>	<b>32640</b>
ECO38-3LN/4	4	350	<b>max</b>	<b>32704</b>	<b>32640</b>	420	9½	30077	27610

NOTE 1) **DSR:** P[11] = 4, P[12] = 3, P[13] = 16384, with STAB trimmer enabled  
 NOTE 2) For standard application; for special application: **STAB=4** → L[33]=8576 → L[53]=2244;  
 NOTE 3) For standard application; YY 230V/60Hz and singlephase Δ 230V/50Hz: **STAB=6** → L[33]=16384 → L[53]=8192;  
 NOTE 4) Dedicated winding  
 NOTE 5) **DSR/A:** P[11] = 5, P[12] = 1, P[13] = 26624, with Fcig<sub>60</sub>(L[53]) = Fcig<sub>50</sub>(L[53]) = L[53]

**TABLE 11 NPE32/4: ADVISED STAB TRIMMER SETTING ON DSR<sup>(1)</sup> Fw Rel. 15**

NPE32 1-PHASE <sup>(4)</sup>		230V / 50Hz				240V / 60Hz			
Type	Poles	S [KVA]	STAB	L[33]	L[53]	S [KVA]	STAB	L[33]	L[53]
NPE 32-A/4	4	6,4	6 ½	18368	10296	8,4	n.a.	n.a.	n.a.
NPE 32-B/4	4	8,7	5 ½	14400	6328	10,5	5 ½	14400	6328
NPE 32-C/4	4	10,8	6	16384	8192	13	6	16384	8192
NPE 32-D/4	4	13,8	7	20288	12561	17	5 ½	14400	6328
NPE 32-E/4	4	18,5	n.a.	n.a.	n.a.	22	6	16384	8192
NPE 32-F/4	4	22,5	6	16384	8192	26,5	6	16384	8192

NPE32 3-PHASE		115/200/230/400V 50Hz				138/240/277/480V 60Hz			
Type	Poles	S [KVA]	STAB	L[33]	L[53]	S [KVA]	STAB	L[33]	L[53]
NPE 32-A/4	4	7,5	4 ½	10559	3402	9	5	12480	4753
NPE 32-B/4	4	11,5	5 ½	14400	6328	14	5	12480	4753
NPE 32-C/4	4	13	n.a.	n.a.	n.a.	16	n.a.	n.a.	n.a.
NPE 32-D/4	4	17	5 ½	14400	6328	21	5	12480	4753
NPE 32-E/4	4	25	6	16384	8192	31	5	12480	4753
NPE 32-F/4	4	27,5	5 ½	14400	6328	34	5	12480	4753

**TABLE 12 ECO40-43-46: ADVISED STAB TRIMMER SETTING ON DSR<sup>(5)</sup> Fw Rel. 15**

Generator		Nominal Frequency = 50Hz				Nominal Frequency = 60Hz			
Type	Poles	S [KVA]	STAB	L[33]	L[53]	S [KVA]	STAB	L[33]	L[53]
ECO40-1S/4	4	400	9	28096	24090	480	7	20288	12561
ECO40-2S/4	4	450	8½	26176	20910	540	8	24191	17860
ECO40-3S/4	4	500	9	28096	24090	600	8½	26176	20908
ECO40-1L/4	4	550	9	28096	24090	660	8½	26176	20908
ECO40-1.5L/4	4	620	9	28096	24090	744	n.a.	n.a.	n.a.
ECO40-2L/4	4	680	9½	30077	27610	816	7	20288	12561
ECO40-VL/4	4	720	9	28096	24090	864	7½	22208	15051
ECO43-1SN/4	4	800	9	28096	24090	960	7½	22208	15051
ECO43-2SN/4	4	930	9	28096	24090	1116	8	24191	17860
ECO43-1LN/4	4	1100	9	28096	24090	1320	8½	26176	20908
ECO43-2LN/4	4	1300	9½	30077	27610	1560	8	24191	17860
ECO43-VL/4	4	1300	9½	30077	27610	1560	8	24191	17860
ECO46-1S/4	4	1500	8	24191	17860	1800	6½	18368	10296
ECO46-1,5S/4	4	1800	9	28096	24090	2160	8½	26176	20908
ECO46-2S/4	4	1800	8½	26176	20908	2160	8	24191	17860
ECO46-1L/4	4	2100	max	32704	32640	2520	9	28096	24090
ECO46-1,5L/4	4	2500	9	28096	24090	3000	9	28096	24090
ECO46-2L/4	4	2500	9½	30077	27610	3000	9	28096	24090

- NOTE 1) **DSR:** P[11] = 4, P[12] = 3, P[13] = 16384, with STAB trimmer enabled  
 NOTE 2) For standard application; for special application: **STAB=4** → L[33]=8576 → L[53]=2244;  
 NOTE 3) For standard application; YY 230V/60Hz and singlephase Δ 230V/50Hz: **STAB=6** → L[33]=16384 → L[53]=8192;  
 NOTE 4) Dedicated winding  
 NOTE 5) **DSR/A:** P[11] = 5, P[12] = 1, P[13] = 26624, with Fcig<sub>60</sub>(L[53]) = Fcig<sub>50</sub>(L[53]) = L[53]

### 3. Excitation Overcurrent

#### 3.1 Description

The DSR regulator is equipped with an excitation (main rotor) winding temperature estimator. An estimate of the temperature is memorised in real time (and can be read) at location 45. The progress of the temperature is of the exponential type (see figure 7).

Through parameter 22 or the AMP trimmer, it is possible to define a limit (which involves intervention of alarm 5) to the excitation voltage and therefore to the temperature.

The function of this alarm is not only to signal an excessive temperature, but it also has an active function in reducing the cause. In fact, an adjustment ring takes control of the voltage generated when the threshold set is exceeded: This reduces the voltage to the point of reducing the excitation current by a value compatible with the ability of thermal dissipation of the machine. The stability of the adjustment in the event of over-excitation alarm can be set with parameters 28 and 29. The default values are suitable for the great majority of machines.

#### WARNING !

If the magnetic gain of the alternator is high, unstable situations can be created upon intervention of the protection, therefore it is necessary to adjust parameters 28 and 29 (in general it is sufficient to lower parameter 28). As you can see in figure 7, when the estimated temperature (represented by the continuous line) reaches the threshold value set in parameter 22, the reduction of excitation current (and consequent drop in voltage generated) brings about the stabilisation of the temperature near a limit value.

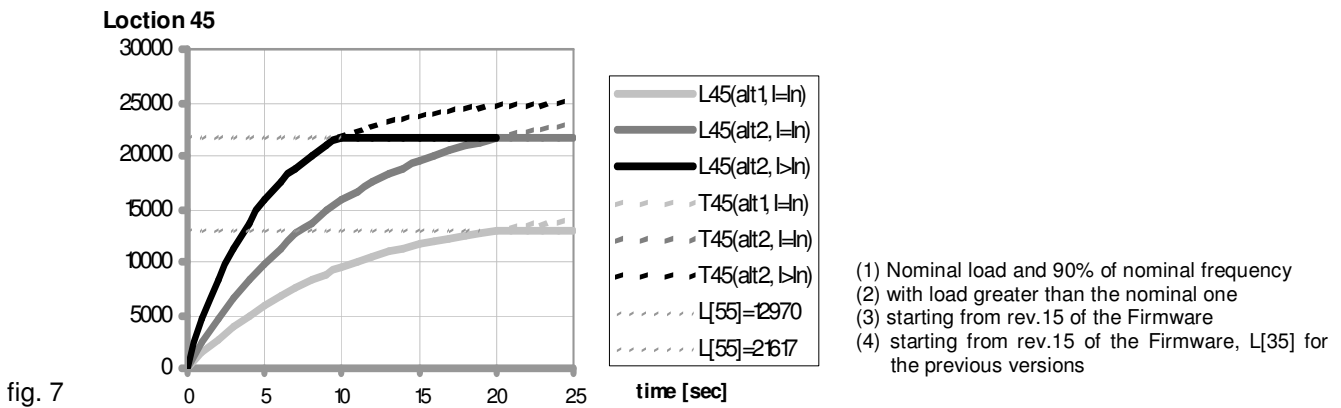

#### Curve Description

L45 (alt1, I=In) : value read at location 45 with a certain alternator <sup>(1)</sup>

L45 (alt2, I=In) : value read at location 45 with a second alternator of a different type <sup>(1)</sup>

L45 (alt2, I>In) : value read at location 45 with the second alternator during overloading <sup>(2)</sup>

T45 (alt1, I=In) : value that would be read at location 45 with the first alternator, without protection <sup>(1)</sup>

T45 (alt2, I=In) : value that would be read at location 45 with the second alternator, without protection <sup>(1)</sup>

T45 (alt2, I>In) : value that would be read at location 45 with the second alternator during overloading, without protection <sup>(2)</sup>

L[55]=12970 Represents the value of the current limit set using the AMP trimmer or the P[22] parameter for the first alternator <sup>(3)</sup>

L[55]=21617 Represents the value of the current limit set using the AMP trimmer or the P[22] parameter for the second alternator <sup>(3)</sup>

#### 3.2 Calibration with a supervising unit

Use the following procedure in order to calibrate the overload protection:

- 1) Lower the underspeed protection threshold, rotating the Hz trimmer counter clockwise (if it has been enabled from the **Configuration Menu**) or by entering 0 at location 21.
- 2) Rotate the AMP trimmer completely in the clockwise direction (if it has been enabled from the **Configuration Menu**) or enter 32767 at location 22.
- 3) Apply the nominal load to the alternator.
- 4) Decrease the speed by 10%
- 5) Read the value shown at location 45, two minutes after reducing the speed.
- 6) If the AMP trimmer is enabled, rotate it counter clockwise until the value shown at location 55<sup>(4)</sup> becomes the same as the value read at point 5 (location 45); otherwise (trimmer not enabled) enter the value read at point 5 (location 45) at location 22.

7) Alarm 5 should come on (visible from both the DSR Terminal control panel and because there is a change in the flashing indicator light) and the voltage should start to drop.

8) By going back to the nominal speed, alarm 5 should disappear in a few seconds and the voltage of the generator should increase to the nominal value.

### 3.3 Calibration without a supervising unit

NOTE: This calibration can be performed only if the AMP trimmer has been previously enabled.

Use the following procedure in order to calibrate the overload protection:

- 1) Rotate the Hz trimmer entirely in the counter clockwise direction
- 2) Apply the nominal load to the alternator.
- 3) Decrease the speed by 10%
- 4) Two minutes later slowly rotate the AMP trimmer in the counter clockwise direction until there should be a decrease in the voltage value of the generator and alarm 5 should come on (visible due to a change in the flashing indicator light)
- 5) Under these conditions, adjust the AMP trimmer, until the output voltage value is 97% of the nominal value: alarm 5 is still activated.
- 6) Return to the nominal speed; alarm 5 should disappear in a few seconds and the generator voltage should increase to the nominal value.
- 7) Adjust the trimmer as indicated in the following paragraph 4.



**NOTE:** When using the machine in single phase, or for voltages different from the one pre-set at the factory, recalibration of the AMP and STAB potentiometers could be necessary.

## 4. Underspeed

### 4.1 Description

For speeds lower than a programmable threshold, the machine voltage is no longer constant, but is regulated proportionately with the frequency at a ratio, which is also programmable, as shown in figure 8a and 8b. The intervention threshold depends upon:

- the status of jumper 50/60 (connector CN1 - terminals 12 and 13) if enabled from the **Configuration Menu**.
- the status of the 50/60 setting in the **Configuration Menu**
- the position of the Hz trimmer if enabled from the **Configuration Menu**
- the value entered at location 21.

Activation of the function with voltage proportionate to the frequency is signalled by activation of alarm 6 (visible from the DSR Terminal control panel and due to a change in the flashing indicator light).

**Parameter 21** (equivalent to the Hz trimmer) sets the Underspeed protection intervention threshold; if this is set on 16384, the protection cuts in at 45 Hz (if the 50/60 jumper and 50/60 flag in the Configuration Menu are not present) or at 54 Hz (if the 50/60 jumper is enabled or the 50/60 flag is active in the Configuration Menu). Values between 0 and 16384 proportionately lower the threshold, respectively to 40 Hz and 48 Hz; values between 16384 and 32767 proportionately raise the threshold, respectively to 50 Hz and 60 Hz.

Once the underspeed protection has intervened, the frequency is proportionately reduced, as indicated in figure 8a and 8b. **Parameter 23** sets the slope of the voltage/frequency curve; the default value is 9000. An increase in the value of P23 involves a greater reduction of the voltage as a function of the reduction in frequency. A decrease in the value of P23 involves a lower reduction of the voltage until the limit of P[23]=0, which means that there is no reduction in voltage.



**WARNING:** Overheating could occur, which is dangerous for the machine, if the voltage is not lowered enough to decrease the frequency and the alternator is functioning at a reduced speed.

### 4.2 Calibration with a supervision unit

Use the following procedure in order to calibrate the underspeed protection:

- 1) If the machine has to operate at 60 Hz, make sure the bridge, between terminals 12 and 13 of connector CN1, is inserted, if it is enabled from the **Configuration Menu**, or activate 50/60 from the same menu.
- 2) If the Hz trimmer is enabled, the value of the protection intervention threshold is read at location 34, otherwise it is entered directly at location 21.  
The value 16384 entered at location 21 (or read at location 34) corresponds to an intervention at 45/54 Hz (depending on whether 50/60 is activated or not).  
Values between 0 and 16384 correspond to an intervention that varies from 40/48 Hz to 45/54Hz.

- Values between 16384 and 32767 correspond to an intervention that varies from 45/54 Hz to 50/60Hz.
- 3) When the speed drops below the threshold value, generator voltage begins to drop and the alarm is shown simultaneously through the indicator light and DSR Terminal control panel.
  - 4) By increasing speed, the generator voltage will normalise and the 6 alarm will disappear.

#### 4.3 Calibration without a supervision unit

NOTE: This calibration can be performed only if the Hz trimmer and 50/60 jumper have been previously enabled.

Use the following procedure in order to calibrate the under speed protection:

- 1) Rotate the Hz trimmer entirely in the counter clockwise direction.
- 2) If the machine has to operate at 60 Hz, ensure that the bridge is inserted between terminals 12 and 13 of the CN1 connector.
- 3) Bring the generator to 90% of the nominal speed.
- 4) Slowly turn the “Hz” trimmer, rotating it clockwise until the generator voltage begins to drop and ascertain that the indicator light simultaneously begins flashing rapidly.
- 4) By increasing speed, the generator voltage will normalise and the alarm will disappear.
- 6) Set the speed to the nominal value.

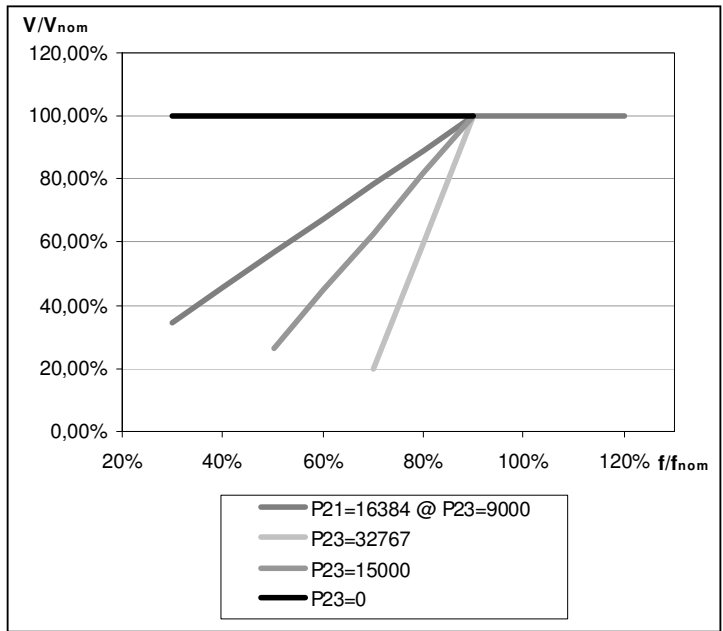
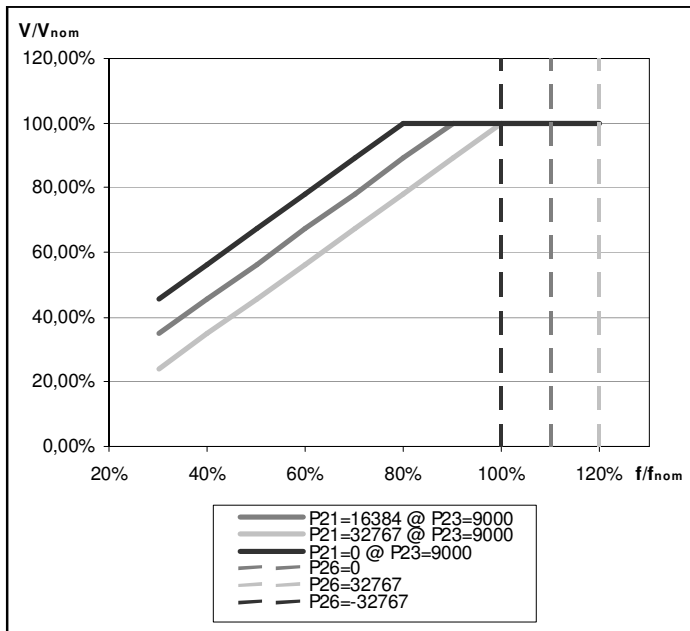

fig. 8a: Underspeed and Overspeed protection, P[21] e P[26]

fig. 8b: Voltage slope in underspeed protection, P[23]

## 5. Overspeed

**Parameter 26** sets the overspeed alarm intervention threshold; if it is set on 0, the signal cuts in at 55 Hz (if the 50/60 jumper and 50/60 setting in the Configuration Menu are absent) or at 66Hz (if the 50/60 jumper is present and enabled or the 50/60 flag in the Configuration Menu is activated). Values between 65535 (-1) and 32768 (-32767) lower the threshold proportionately to 50 Hz and 60 Hz, respectively; values between 0 and 32767 raise the threshold proportionately, respectively to 60 Hz and 72 Hz; refer to the broken lines in fig. 8a and 8b.

## 6. Other parameters

### 6.1 Vout / Vaux Ratio

In order to guarantee sufficient feeding voltage at speeds lower than the Hz protection intervention threshold, a limit to the reduction of voltage has been foreseen, as a function of frequency.

The limit concerns regulated voltage (Vout). Should the DSR be powered through an auxiliary winding, it must be born in mind that the voltage generated by the winding (Vaux) may not have the same Vout value; Vaux is considered proportionate to Vout and the proportional coefficient is determined by **parameter 14**.

If the DSR is powered directly by the regulated phase, parameter 14 should be set on 0; in case it is powered by auxiliary winding, the voltage (Vaux) must be measured, in no-load conditions and with output voltage regulated on the nominal value (Vout); the value of parameter 14 can be obtained with the following formula:

$$P[14] = 32767 \cdot \left( \frac{V_{out}}{V_{aux}} - 1 \right)$$

## 6.2 V/F slope at start up

**Parameter 24** sets the gradient of proper voltage / frequency at start up. After the underspeed alarm frequency threshold has been exceeded (set by parameter P[21] or by the Hz trimmer), the work ramp is used (parameter P[23]).

The default value is 12000; an increase in the value of P24 will cause a greater reduction of low frequency voltage; a decrease in the value of P24 will cause a lower reduction in voltage, up to the limit of P[24]=0, which means that no reduction in voltage will take place.



**WARNING:** If the voltage is not lowered enough with low frequency and the alternator is operating in these points, overheating could develop that is dangerous for the machine.

## 6.3 Short circuit time

**Parameter 25** defines the operating time with the alternator short circuited, which is expressed in tenths of a second (from 0.1 seconds to 25.5 seconds); after this period of time the regulator goes to the blocked status; a value of 0 disables the blockage.

## CONTROLLING OF REGULATOR ALARMS

### 1. Table of recapitulation

TABLE 13 : ALLARMS LIST		
N.	Description of event	Action
1	Checksum EEprom	Reset default data - Blockage
2	Over voltage (@ $\omega_N$ )	APO
3	Under voltage (@ $\omega_N$ )	APO
4	Short circuit	APO, maximum current - Blockage
5	Excitation Overcurrent	APO, Reduction of excitation current
6	Underspeed	APO, V/F Ramp
7	Overspeed	APO

The status of active alarms is stored at location 38, which can be read with the serial connection. The index of bits that have a value of 1 corresponds to the active alarm. If the regulator is correctly working (no alarm active) the bit 11 will be high.

TABLE 14 : ALLARMS FLAG AT LOCATION 38																
Location 38 (third "STATUS" box)																
B <sub>15</sub>	B <sub>14</sub>	B <sub>13</sub>	B <sub>12</sub>	B <sub>11</sub>	B <sub>10</sub>	B <sub>9</sub>	B <sub>8</sub>	B <sub>7</sub>	B <sub>6</sub>	B <sub>5</sub>	B <sub>4</sub>	B <sub>3</sub>	B <sub>2</sub>	B <sub>1</sub>	B <sub>0</sub>	
32768	16384	8192	4096	2048	1024	512	256	128	64	32	16	8	4	2	1	
				A12	A11	A10	A9	A8	A7	A6	A5	A4	A3	A2	A1	
J50/60	-	Reserved	Reserved	OK	-	-	-	-	Overspeed	Underspeed	OverExcitation	Cto.Cto.	Undervoltage	Overvoltage	Check sum	

Example:

Location 38 = 48 = 000000000110000<sub>2</sub> : it means that Bits B5 and B4 are at 1, therefore alarms A6 and A5 are active

### 2. Alarm signals with the indicator lights

During normal operation and a duty cycle of 50% (OK in fig. 9) an indicator light mounted on the board flashes every 2 seconds; it flashes differently in the event of intervention or alarm, as indicated in fig. 9.

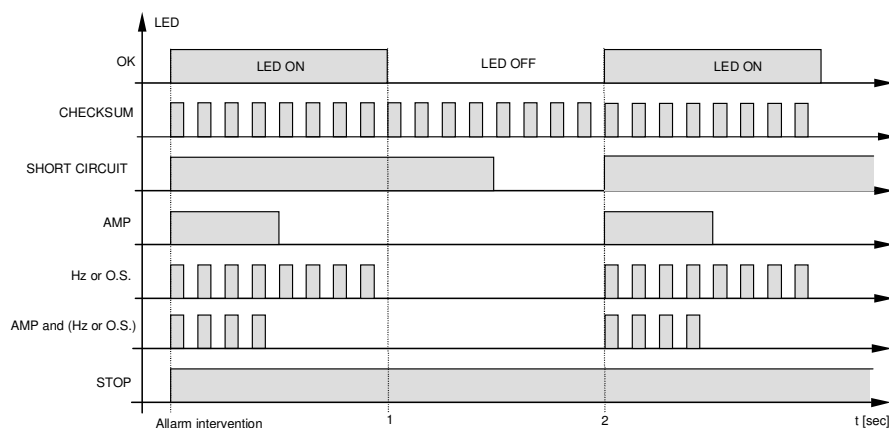
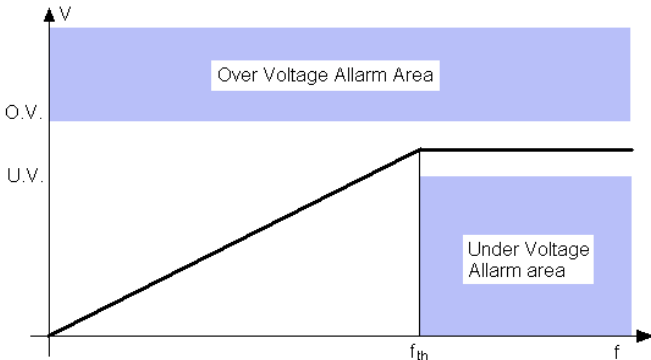

fig. 9

## 2. Description of alarms

N.	Description of event	Action
1	EEPROM checksum	Verified upon start up (after DSP reset and initialisation of the peripheral). The actions undertaken are: signalling, locating of default settings, saving in EEPROM and regulator blockage. When the machine is switched on again, if the EEPROM is damaged, the alarm will be repeated. Otherwise the regulator will begin to function with default parameters.
2	Over Voltage	The alarm is not visualised, the APO output is active and memorised. This can be caused by abnormal operating conditions (such as overspeed or overloading) or by a breakdown of the regulator. The over voltage alarm is activated if the output voltage is lost. The over voltage is calculated using an opportune template, as a function of the speed and is inhibited during transition, for 2 seconds. In the template for the calculation the threshold is set at 5% above the nominal value.  
3	Under voltage (@ $\omega_N$ )	The alarm is not visualised, is stored and the APO output is active. The under voltage is calculated using an opportune template as a function of the speed (which can be seen in the description of the over voltage alarm); in the template for the calculation the threshold is set at under 5% the nominal value. It intervenes only above the underspeed alarm threshold; it is practically inhibited by this. It is also inhibited in the event of intervention of the Excitation over voltage and during transients.
4	Short circuit	The alarm is disabled under 20 Hz, is visualised upon activation of the action and memorised. Tolerated short circuit time goes from 0,1 to 25,5 seconds (programmable in 100 ms steps); then the regulator is blocked after saving DD and TT and signals the STOP status. With the time in short circuit set on zero, the blockage is disabled. The STOP condition causes a fall in excitation, with consequent switching off and successive restarting of the regulator and therefore repetition of the cycle.
5	Excitation Overcurrent	The function of this alarm is not only to signal an excessive temperature, but it also has an active function in reducing the cause. In fact, an adjustment ring takes control of the voltage generated when the threshold set is exceeded the action involves reduction of the excitation current and therefore output voltage. The available parameter is the "threshold", which determines the value of equilibrium at which the system is stabilised. The alarm is signalled and stored. For calibration see the paragraph on excitation overcurrent.
6	Underspeed	Signalling (immediate) and activation of the V/F ramp. This alarm also appears when the machine is started and stopped. The alarm is not saved among EEPROM data. The alarm intervention threshold depends upon the status of the 50/60 jumper (hardware or software) and on the position of the Hz trimmer or the value of parameter 21. Under the threshold the V/F ramp is active.
7	Overspeed	This is visualised in the same manner as the underspeed alarm and does not involve actions on control, but the alarm is stored. The overspeed condition may provoke an over voltage as in the case of capacitive load. The threshold can be set with parameter 26.



**NOTE:** Though the voltage is continuously regulated, the DSR will switch off if the frequency goes under 20Hz. To reset the system it is necessary to stop completely the alternator.



### 3. APO Output

The APO output (Active Protection Output-open collector transistor – connector CN1 - terminals 14 and 15) is normally open during normal operation. It closes (with a programmable delay between 0 to 15 seconds) when, among all the alarms, one or more than one, separately selectable, is active.

The selection of which alarms involve the activation of the APO depends on the value entered at **location 17**.

The transistor is also open when no alarm is activated and with the alarm active, the corresponding enabling bit is set on 0.

The value to set at location 17 is made up of two parts: one allows selection of the alarms that activate the contact, while the other permits setting of the delay for intervention. Use the following procedure to calculate the value to set at location 17:

- With reference to table 8 add up the decimal numbers corresponding to the alarms for which the APO must be activated, obtaining a number, "B". (Example: since it is desired to activate the APO in the case of over voltage and overspeed, the formula is  $B = 2 + 64 = 66$ )
- Multiply the delay it is desired to set (whole numbers from 0 to 15 seconds) for the fixed value of 4096. The number  $A = (0..15) * 4096$  is obtained. (Example: since a delay of 5 seconds is required, the formula is obtained  $A = 5 * 4096 = 20480$ ).

The sum of  $A + B$  must be entered at location 17 (in the previous example  $20480 + 66 = 20546$ )

TABLE 15 : ALLARMS SETTING THAT ACT ON THE APO											
A12	A11	A10	A9	A8	A7	A6	A5	A4	A3	A2	
-	-	-	-	-	Overspeed	Underspeed	Over Excitation	Cto.Cto.	Under voltage	Over voltage	
2048	1024	512	256	128	64	32	16	8	4	2	

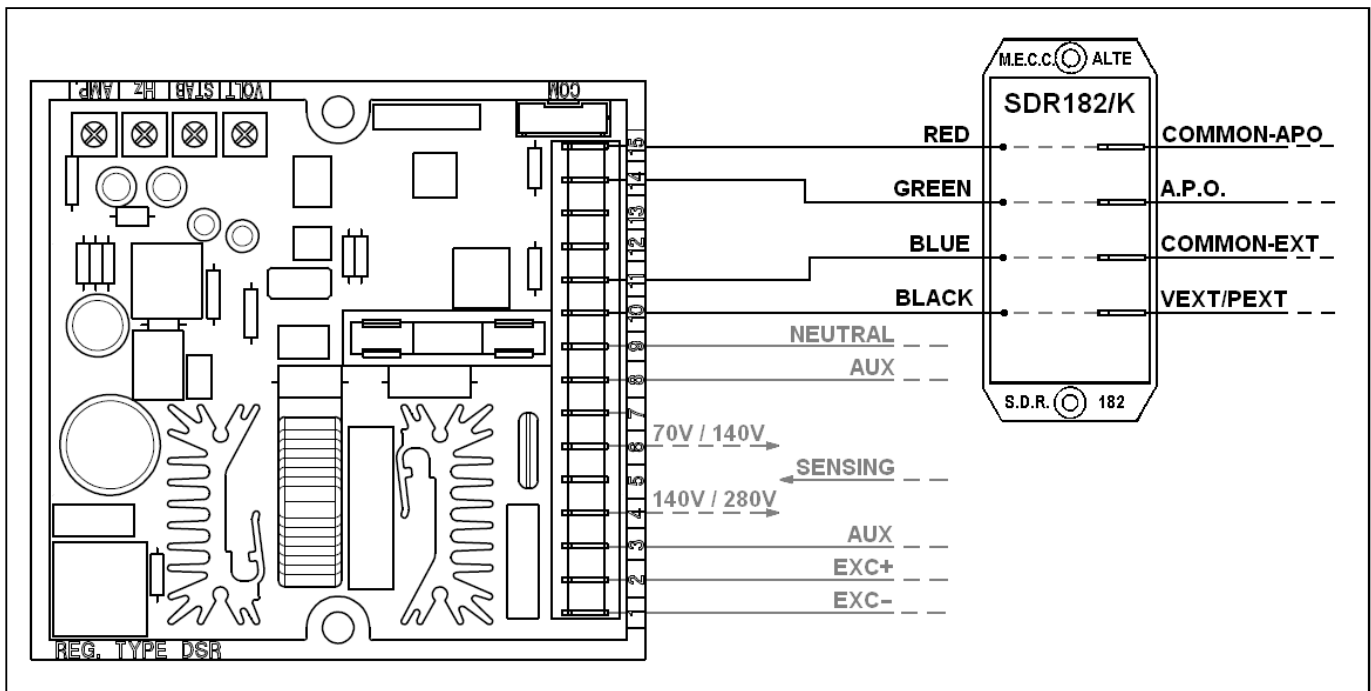

Fig. 10: EMI SDR182/K filter connection

### 4. DSR operation time <sup>(1)</sup>

If the regulator is working correctly (no alarm) A12 will be active and the bit 11 will be High at location 38. When we see one alarm, the A12 is deactivated, bit 11 is reset at location 38 and operation time is stored. The total operation time of the regulator is obtained, after the download of the alarms, by adding all the times TT (last column of the file .alr).

For the procedure please refers to the function "Download Alarm" at the paragraph "Description of function" of chapters "USE OF PROGRAMMING SOFT. AND MONITORING OF THE DSR TERMINAL" and "APPENDIX A".

NOTE (1): starting from rev.11 of the Firmware

## DI1 COMMUNICATIONS UNIT

### Description:

The DI1 interface device (fig. 11) permits connection of the DSR digital regulator to a programming and monitoring device, whose functions may include the following:

- Repetition, or visualisation, of the status variable of the generator, even from a remote location
- Setting of single parameters
- Uploading and downloading of settings files
- Status readings (alarms, measured values)
- Readings of information of the alarm memory.
- Interface conversion towards other field buses or communications networks.

The DI1 interface must be positioned near the DSR. The COM connector of the DSR regulator is connected to the CN2 connector of the DI1 interface with the special cable supplied by Mecc Alte.

The programming and control unit may be made up of a PC, a PLC or other equipment, providing it has at least one of the interfaces of the DI1 device.

The following serial interfaces available on the DI1 communications unit are:

- RS232 without handshake (3 wires) on CN3 connector
- RS485 two wires half duplex on CN4 connector (DTE<sup>(1)</sup>, TxRTS, RxRTS)

The connection between one DSR regulator and a PC is shown in fig. 13.

When necessary, the DI1 interface permits insertion of the regulator in an RS485 network with other regulators or devices of a different type, but with the same type of bus, as shown in fig. 4.

The DI1 interface can be connected to a USB port with an RS232 - USB converter (not supplied by mecc alte). For more information refer to the technical guide "USB - Serial converter" (available only in Italian/English).

The DI1 interface also permits isolation of the A.P.O. contact of the regulator : terminal 14 of the DSR must be connected to terminal 5 of CN1 (as indicated with the dotted line in fig. 12).

Two types of APO insulated contacts are available on connector CN5 (which cannot be used simultaneously):

- Solid state switch, Max. 30V - 100mA (terminals 3 and 4)
- Electro-mechanical switch, 24Vdc/120Vac – 6A<sup>(2)</sup> (terminals 5, 6 and 7)

**WARNING:** for the correct operation of the APO insulated contacts, the cable between the COM connector of the DSR regulator and the CN2 connector of the DI1 interface MUST be connected.

NOTE (1) DTE = Data Terminal Equipment

NOTE (2) Current on resistive load

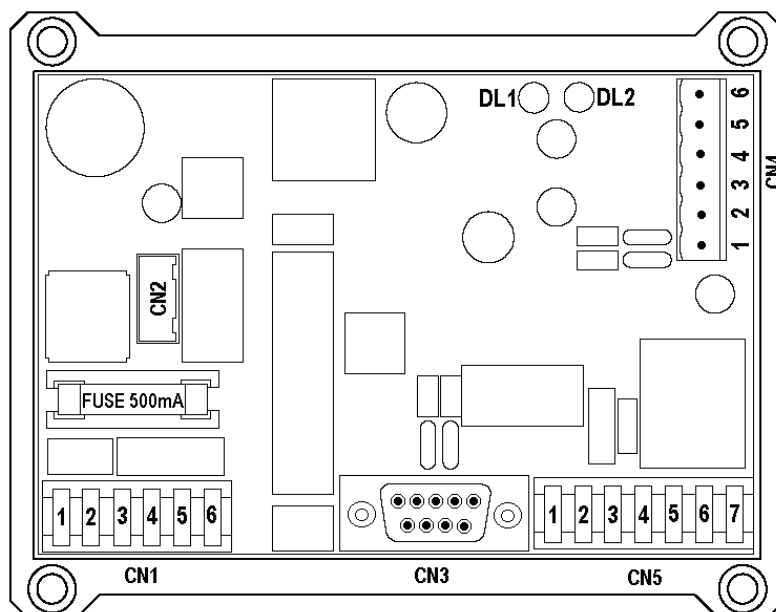

Fig. 11: layout of the DI1 communications interface

Instruction Manual DSR digital regulator - rev. 05 - pag. 26

### 3. Inputs and Outputs: Technical Characteristics

TABLE 16: CONNECTOR CN1				
Terminal	Name	Function	Specifications	Notes
1	Aux/Exc+	Power	AC voltage: 40V - 270V Frequency: 15Hz - 72Hz DC Voltage: 40V - 380V	The terminals are connected together on the board: 1 with 2 and 3 with 4
2	Aux/Exc+			
3	Aux/Neutral			
4	Aux/Neutral			
5	A.P.O.	Active protections input	Voltage: 3,3V	Connection to the APO output of the DSR to have the APO output isolated (CN5 3-4) or APO Relay (CN5 5, 6 and 7)
6	DSR Common			

TABLE 17: CONNECTOR CN3					
DIAGRAM	Pin N°	Function	Specifications	Notes	
	1	-	Not connected	Reading and writing of operational parameters, reading of stored alarms. A standard serial cable may be used with 9 pins SUB-D connectors.	
	2	232 - TX	RS232 TX - Insulated		
	3	232 - RX	RS232 RX - Insulated		
	4	-	Not connected		
	5	232/485 GND	Common RS232/RS485 - Insulated		
	6	-	Not connected		
	7	-	Not connected		
	SUB-D 9 pin connector, female, top view	8	-		Not connected
		9	-		Not connected

TABLE 18: CONNECTOR CN4			
Pin N°	Name	Description	Notes
1	485 A	RS485 channel A - Insulated	The terminals are connected together on the board. 1 with 4, 2 with 5 and 3 with 6 for the realisation of a regulators network (see fig. 4)
2	485 B	RS485 channel B - Insulated	
3	232/485 GND	Common RS232/RS485 - Insulated	
4	485 A	RS485 channel A - Insulated	
5	485 B	RS485 channel B - Insulated	
6	232/485 GND	Common RS232/RS485 - Insulated	

TABLE 19: CONNECTOR CN5				
Terminal	Name	Function	Specifications	Notes
1	232/485 GND	External power	Voltage: 9 - 14V	
2	VDC		Current : 100mA	
3	APO1		Type of contact: Insulated Current: 100mA Voltage: 30V	Do not use as contact if the bridge is inserted between terminals 1 and 3 of CN5
4	APO2			
5	APO-NC	Normally closed, opens with APO active	Type of contact: Insulated Current: 6A Voltage DC 24V Voltage AC 120V	Current specifications on resistive load. For use of relay insert a bridge between terminals 1 and 3 of CN5
6	APO-C	Common of relay		
7	APO-NO	Normally open, closes with APO active		

### 3. Powering DI1

The DI1 board must be powered separately :

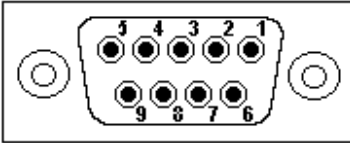
- 1) On connector CN1 (terminals 1-2 and 3-4) through the same power as the DSR; for this purpose, the power terminals on CN1 have been duplicated (Fig. 12)
- 2) On connector CN1 (terminals 1 and 4) through a dedicated source (AC: 40V/15Hz - 270V/72Hz or DC: 40V - 380V)
- 3) Alternatively, on connector CN5 (terminals 1 and 2) through a completely isolated source in DC (9 – 14V) see fig. B2 e B4 in Appendix B



Warning: The use of a non-isolated power on connector CN5 may cause communication problems that damage the DSR regulator, the DI1 interface and the connected devices.

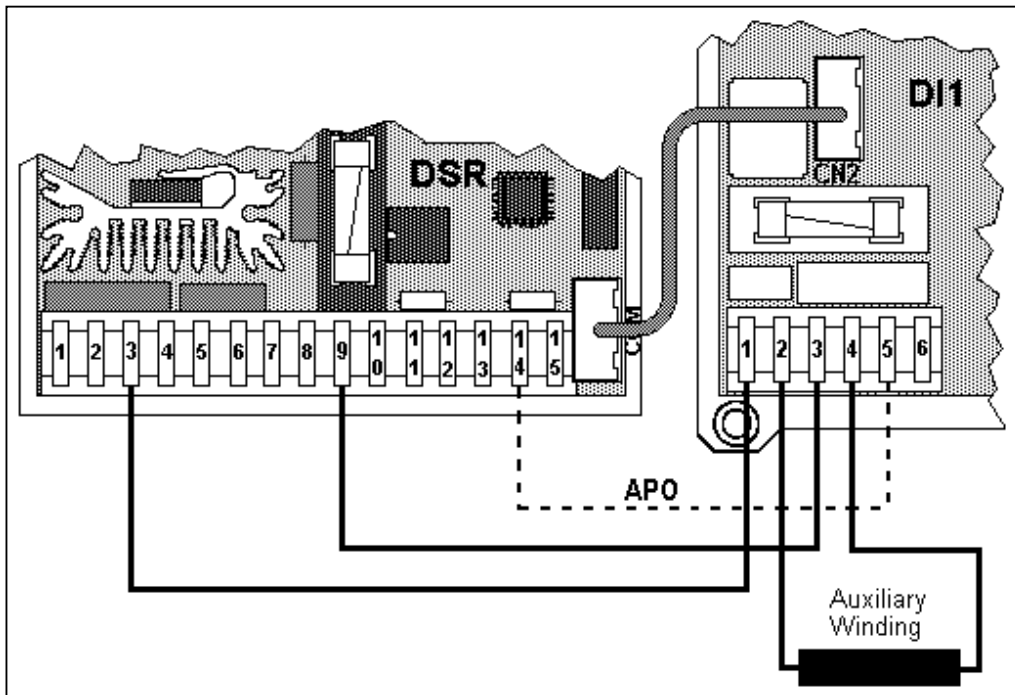

fig. 12: Example of power and connection (optional) of APO signal

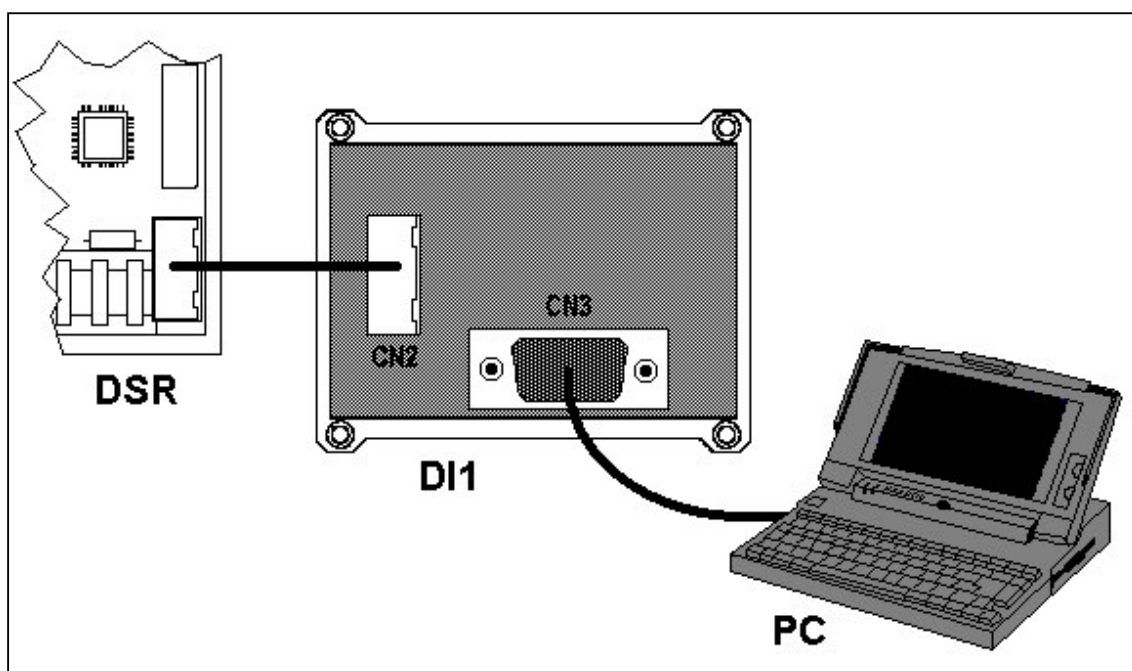

Fig. 13: RS232 connection between one DSR regulator and PC, through DI1 digital interface.

# USE OF PROGRAMMING SOFTWARE AND MONITORING OF THE DSR TERMINAL

## 1. Installation

Run the “install.exe” program from Windows

This creates the directory **C:\dsrterm**, with the executable code, and creates the link on the desktop. Launch the DSR Terminal program from the Windows desktop.

In case of lack of shortcut dsr\_terminal.lnk on the desktop, it can be copied from **C:\dsrterm**

## 2. Introduction

Upon opening the user interface, the program is presented as indicated in the left part of figure 14.

The connection is confirmed when the indicator **Connected** (16) goes from yellow to green.

If the communication takes place without errors, the **Com STAT** indicator (15) goes from red to green.

**IMPORTANT:** The communication may take place only if all three of the indicators **Connected** (16) **Com STAT** (15) **and Com ERROR** (14) are green. The **ADDRESS** window indicates the slave address with which it is communicating, almost in real time.

## Communication

The **ComPort** menu has 2 functions:

1. **Connect/Disconnect** activates or deactivates the connection with the slave unit (DSR regulator)

2. **Settings** opens a window (as shown in figure 14), through which several parameters, concerning communications, can be set:

- The **Port** setting determines which serial port it is intended to use for communications (COM1 or COM2).
- The parameter **Slave ADDR** refers to the device with which it is intended to communicate (location 1).
- The parameter **Baud** sets the transmission speed with which the master unit (system supervisor) exchanges data with one or more slave units (digital regulators).

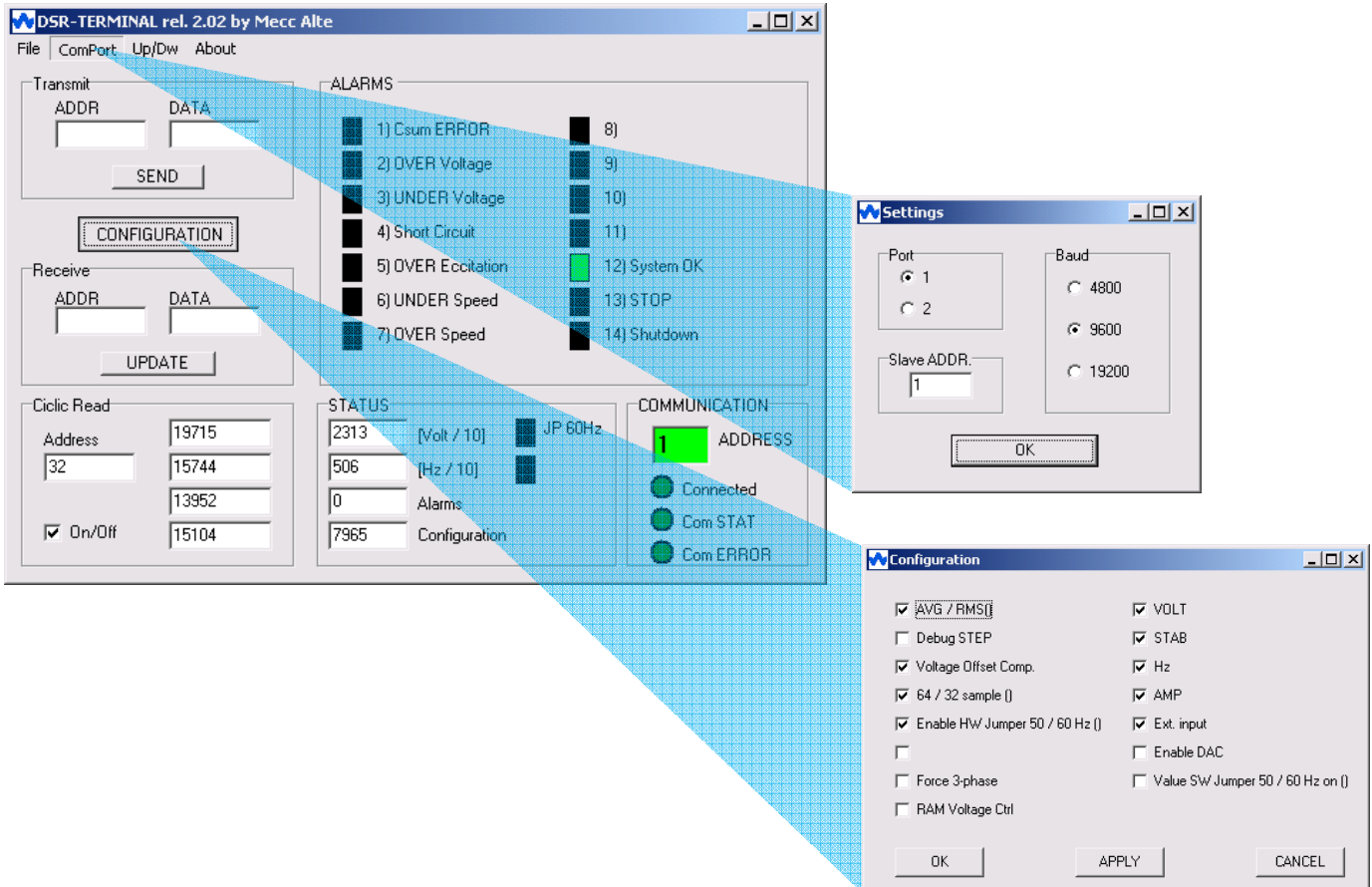

Fig. 14: DSR Terminal user Interface: Settings and Configuration Menu

### 3. Description of Function

The DSR Terminal user Interface is presented as shown in figure 15 and permits programming and monitoring from 1 to 32 slave units connected through serial RS485 or a single unit connected through RS232. The functions available are shown in table 20.

The DSR Terminal user interface is divided into 6 areas with different functions.

**Transmit** : Handles data transmitted towards slave units (DSR)

**Receive** : Displays a single datum requested from slave units (DSR)

**Cyclic Read** : Displays, almost in real time, four pieces of information memorised on consecutive locations in the slave unit (DSR)

**STATUS** : Displays registries from 36 to 39 (measured voltage, measured frequency, active alarm flags)

**ALARMS** : Displays active alarms (alarms and individual word alarm flags are shown in table 15).

**COMMUNICATION** : Displays the status of communication

The **Configuration** Menu

The **Configuration** Menu is indicated in figure 14; it permits setting of configuration flags of the DSR regulator (parameter 10).

**File** Menu

The **File** Menu presents the single option of Exit, to close the DSR Terminal user interface.

**Up/Dw** Menu

The **Up/Dw** Menu is used to load and unload settings files to and from the regulator (which have the extension .dat). The list of parameters is shown in table 3.

There are three possible options:

1. **Upload Data** The "Upload" window opens

- The key **Open** allows selection of files with the .dat or .set extension, which must be loaded.
- The **Upload** key unloads the parameters of settings files into the DSR regulator; if the file has been opened with the .dat extension, all of the parameters are updated, if the file has been opened with the .set extension, only the parameters from 10 to 30 are updated, leaving those from 0 to 9 unaltered.
- The key **Done** closes the Upload window.

2. **Download Data:** The "DownLoad" window opens

- The **DownLoad** key transfers the settings files to the personal computer.
- The key **SaveAll** permits the operator to save the entire settings file (from 0 to 30) with the .dat extension.
- The key **SaveSettings** allows you to save the file with customised data (parameters from 10 to 30) with the .set extension.
- The key **Done** closes the DownLoad window.

3. **DownLoad Alarm:** The "DownLoad Alarm" window opens

- The key **DownLoad** transfers the list of memorised alarms to the personal computer, as many times as the alarms intervened and, for each of them, the duration of the last event and the overall duration (see *Meaning of the info contained in the file .alr*).
- The key **Save** allows the operator to save the alarms file with the .alr extension.
- The key **Done** closes the DownLoad Alarm window.

The **About** Menu

The **About** Menu signals the current release of the DSR Terminal software.

### 4. Settings files

These are appropriately formatted text files; each line:

- starts with a number that represents the **address** of the parameter;
- this number must be followed by a **space** as a separating character;
- the space is followed by a number, which represents the **value** of the parameter,
- it is possible to write an **optional text** alongside the value of the parameter, providing it is separated by at least one **space**.
- Only parameters whose address is present are modified, the others remain unaltered;
- The entire text that follows the symbol "%" is evaluated as a comment and is not taken into consideration

```

% MECC ALTE S.p.A.
% Digital Regulator for DSR Synchronous Alternators
% Settings file
%
% Version of parameters:      15
% Alternator type:           ECO3, ECO28, ECP34, EC038
% Date:                       25/09/12
% Configuration:              RMS, Offset compensation, 32 samples,
%                               Jp 50/60, trimmers and Vext enabled
%                               Connected HW 50/60 and Jp on Pext
%
8  0      Current limit time
9  32767  Current limit level
10 7965   Configuration Word
11 4      Shift to LEFT proportional gain
12 3      Shift to LEFT integral gain
13 16384  Coefficient tying Ki to Kp
14 6000   Vout/Vaux Ratio
15 16384  Reference equivalent to Vext
16 4608   Limitation of Vext Variation
17 126    APO delay and alarm settings
18 20     Step limitation reference
19 0      Reference voltage equivalent to VOLT
20 16384  Stability equivalent to STAB
21 16384  Low frequency protection threshold equivalent to Hz
22 16384  Excitation overcurrent threshold equivalent to AMP
23 9000   V/F slope
24 12000  V/F slope at start up
25 20     Short circuit time (in tenths of a second)
26 0      Overspeed threshold
27 6553   Frequency shutdown (6553 -> 20 Hz)
28 12287  Ki Regulator alarm over excitation
29 24575  Kp Regulator alarm over excitation
30 63600  Resistance discharge accumulator over excitation

```

*Example of .set file*

```

File contatori Allarmi ver. 0.1 ← Heading
Cod allarme - Occorrenze - Ultimo evento - Accumulatore ←

```

- Alarm code
- Number of events
- Last event
- Accumulator

```

1 0 0 0      Checksum EEPROM
2 5 14 153   Overvoltage
3 0 0 0      Undervoltage
4 4 1 4      Short Circuit
5 0 0 0      Excitation Overcurrent
6 37 1 65    Underspeed
7 27 1 27    Overspeed
8 0 0 0      -
9 0 0 0      -
10 0 0 0     -
11 0 0 0     -
12 74 3 92678 Correct working
13 0 0 0     -
14 0 0 0     -

```

↑ Overall duration [s]  
↑ Duration of the last event [s]  
↑ Number of events  
↑ Alarm code (Table 13)

*Meaning of the info contained in the file .alr*

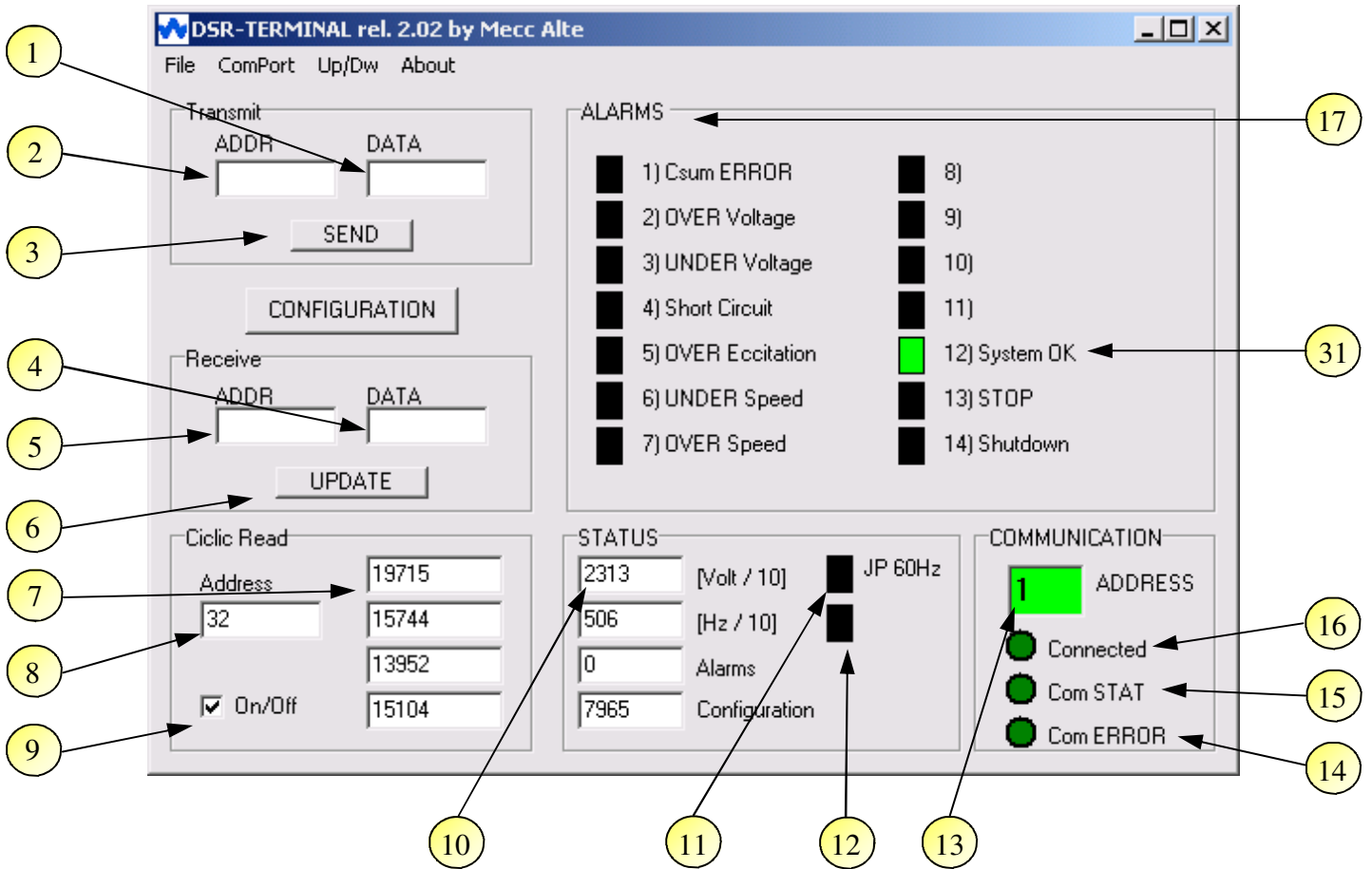

Fig. 15 DSR Terminal User Interface

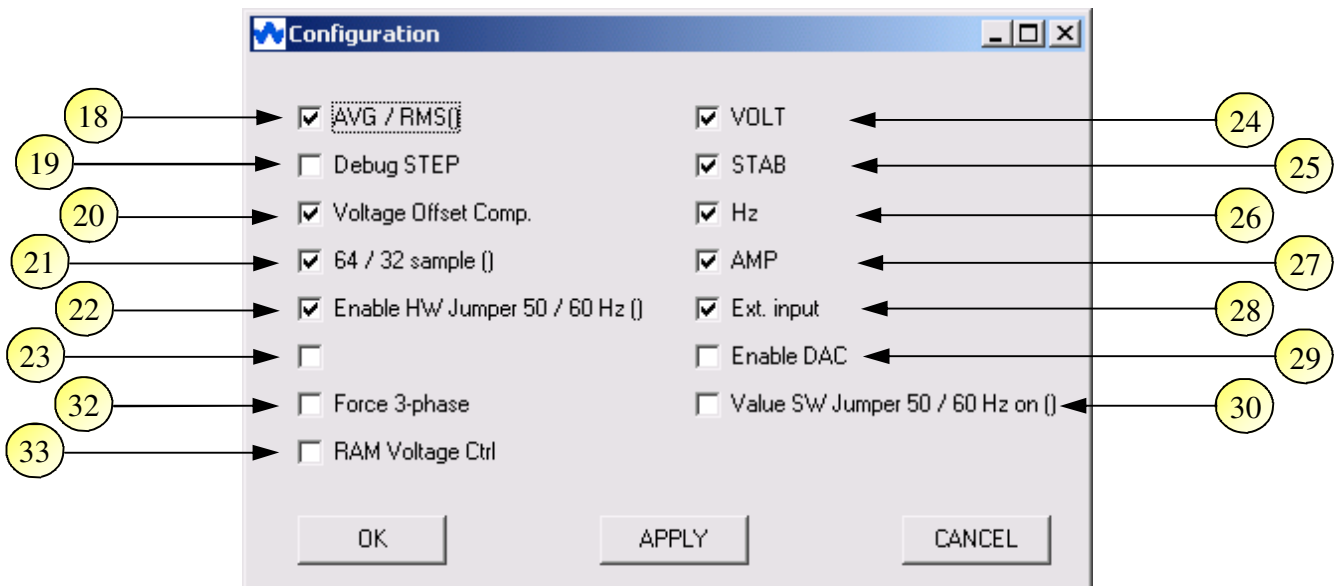

Fig. 16 Configuration Menu



**TABLE 20 : FUNCTIONS OF THE MAIN DSR TERMINAL PANEL OF THE CONFIGURATION MENU**

<b>Ref.</b>	<b>Description of Function</b>
1	Value of parameter to be transmitted to the regulator
2	Address of parameter to be transmitted to the regulator
3	Transmission command
4	Value of parameter requested from regulator (updated following command indicated in 6)
5	Address of parameter requested from regulator
6	Updating command
7	Values of 4 parameters allocated to 4 consecutive addresses (starting from the address indicated in 8 included)
8	Address of the first of the 4 parameters requested from the regulator
9	Activation of updating almost in real time
10	Visualisation of the regulator status (voltage, frequency, active alarms, configuration)
11	50/60Hz Jumper inserted
12	Free for future use
13	Address of Slave with which the unit is communicating
14	Communications error (red indicator)
15	Connection fault (red indicator)
16	Connection and communications working indicator
17	Active alarms signal
18	Setting the regulation on the RMS value
19	Flag activating a periodical variation of reference voltage (for preliminary calibration)
20	Flag activating automatic compensation of the offset in voltage acquisition channels
21	Flag to set sampling on a semi-period
22	Flag enabling reading of 50/60 Hz jumper hardware
23	Not used
24	Flag enabling reading of reference voltage by VOLT Trimmer
25	Flag enabling reading of stability parameter by STAB Trimmer
26	Flag enabling reading of underspeed protection threshold by Hz Trimmer
27	Flag enabling reading of excitation current threshold by AMP Trimmer
28	Flag enabling reading of external voltage input
29	Flag enabling DAC
30	Flag to set nominal machine frequency
31	Correct working (starting from revision 11 of the Firmware)
32	Not used in the DSR
33	The Flag activates the saturation or the numeric mode from L[49] of the remote control voltage <sup>(1)</sup>

NOTE(1): starting from rev.15 of the Firmware.

## APPENDIX A: USE OF MONITORING SOFTWARE “DSR\_Reader”

### 1. Installation

Run the “install.bat” program from Windows

This creates the directory C:\dsrread, with the executable code, and creates the shortcut on the desktop. Launch the DSR\_Reader program from the Windows desktop.

### 2. Introduction

Upon opening the user interface, the program is presented as indicated in the left part of figure 11.

The connection is confirmed when the indicator **Connected** (10) goes from yellow to green.

If the communication takes place without errors, the **Com STAT** indicator (11) goes from red to green.

**IMPORTANT:** The communication may take place only if all three of the indicators **Connected** (10) **Com STAT** (11) and **Com ERROR** (12) are green.

The **ADDRESS** window (9) indicates the slave address with which it is communicating, almost in real time.

The **Connect / Disconnect** pushbutton (2) activates or deactivates the connection with the slave unit (DSR regulator)

### Communication

The **ComPort** menu has 2 functions:

1. **Connect** activates or deactivates the connection with the slave unit (DSR regulator)

2. **Settings** opens a window (as shown in figure 17), through which several parameters, concerning communications, can be set:

- The **Port** setting determines which serial port it is intended to use for communications (COM1 or COM2).
- The parameter **Slave ADDR** refers to the device with which it is intended to communicate (location 1).
- The parameter **Baud** sets the transmission speed with which the master unit (system supervisor) exchanges data with one or more slave units (digital regulators).

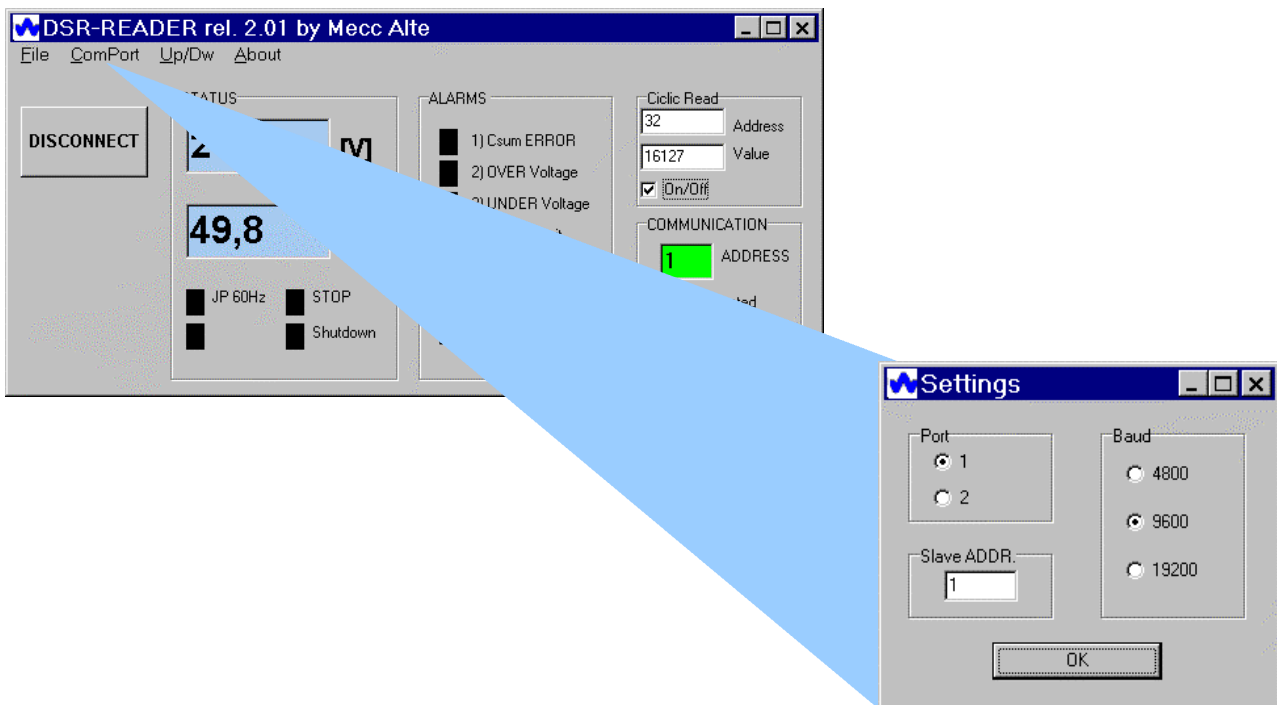

Fig. 17: DSR\_Reader user interface and Settings menu

### 3. Description of Function

The DSR\_Reader user Interface is presented as shown in figure 18 and permits monitoring from 1 to 32 slave units connected through serial RS485 or a single unit connected through RS232.

The functions available are shown in table 21.

The DSR Terminal user interface is divided into 4 areas with different functions.

**STATUS** : Displays the measured voltage and the measured frequency (registries 36 and 37).

**ALARMS** : Displays active alarms.

**Cyclic Read** : Displays, almost in real time, a single datum requested from slave units (DSR)

**COMMUNICATION** : Displays the status of communication

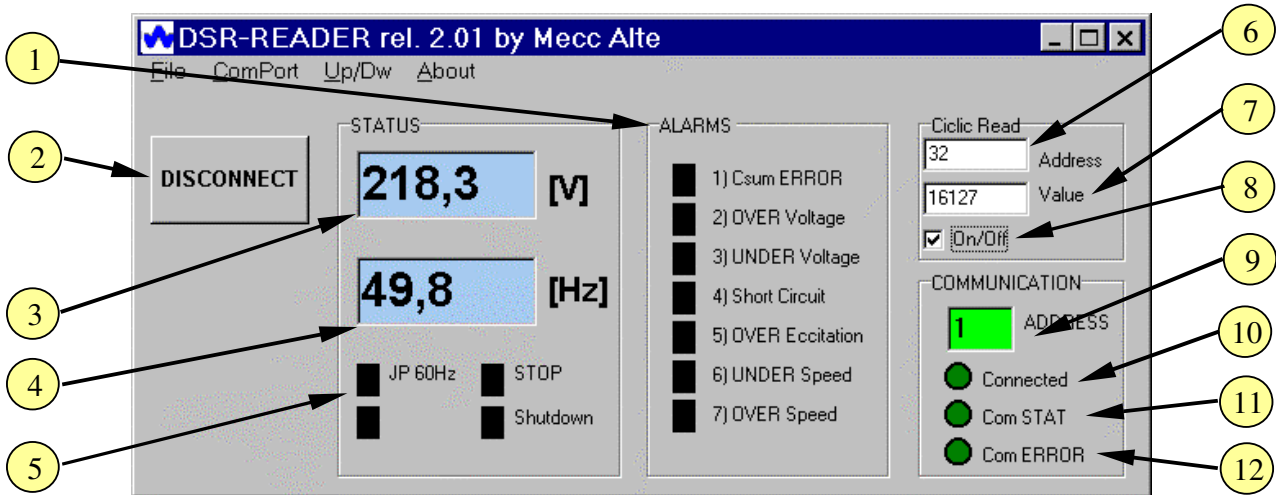

Fig. 18 : DSR\_Reader user interface

TABLE 21 : FUNCTIONS OF THE MAIN DSR\_READER PANEL

Ref.	Description of Functions
1	Active alarms signal
2	Pushbutton activating or deactivating the connection
3	Regulated voltage at bornes 4 - 5 (if connected, or double than voltage at bornes 6 - 7)
4	Measured frequency
5	50/60Hz Jumper inserted
6	Address of parameter requested from regulator
7	Value of parameter requested from regulator (updated following command indicated in 8)
8	Activation of updating almost in real time
9	Address of Slave with which the unit is communicating
10	Connection and communications working indicator
11	Connection fault (red indicator)
12	Communications error (red indicator)

## Others functional menu

### **File** Menu

The **File** Menu presents the single option of Exit, to close the DSR\_Reader user interface.

### **Up/Dw** Menu

The **Up/Dw** Menu is used to unload settings files from the regulator (which have the extension .dat or .set). The list of parameters is shown in table 3 of the Instruction manual. The possible options are limited:

**1. Upload Data** is an unpermitted function

**2. Download Data:** The “DownLoad” window opens

- The **DownLoad** key transfers the settings files to the personal computer.
- The key **SaveAll** permits the operator to save the entire settings file (from 0 to 30) with the .dat extension.
- The key **SaveSettings** allows you to save the file with customised data (parameters from 10 to 30) with the .set extension.
- The key **Done** closes the DownLoad window.

**3. DownLoad Alarm:** The “DownLoad Alarm” window opens

- The key **DownLoad** transfers the list of memorised alarms to the personal computer, as many times as the alarms intervened and, for each of them, the duration of the last event and the overall duration.
- The key **Save** allows the operator to save the alarms file with the .alr extension.
- The key **Done** closes the DownLoad Alarm window.

### The **About** Menu

The **About** Menu signals the current release of the DSR\_Reader software.

## APPENDIX B: DSR SET UP ON A TEST BENCH

The use of a test bench will result in a much easier set up of the DSR and its communication devices. The connection schemes of the DSR and the communication board DI1 are reported from figures 1 to 4, depending on the power source available.



Some of the DSR and DI1 components are working at high voltage and can be potentially dangerous for safety: for this reason it is mandatory to insulate the power source of the regulator from the grid by means of an insulation transformer.

The connection must be accomplished by trained and skilled personnel, perfectly aware of the potential risks of high voltages for health and safety. A full knowledge of this manual is also required for a safe operation on the DSR.

Referring to figures B2 and B4, the 9-14 Vdc power source must be insulated. If not, communication troubles can arise as well as damages to the DSR or DI1 units, or even to any other device connected to the system.

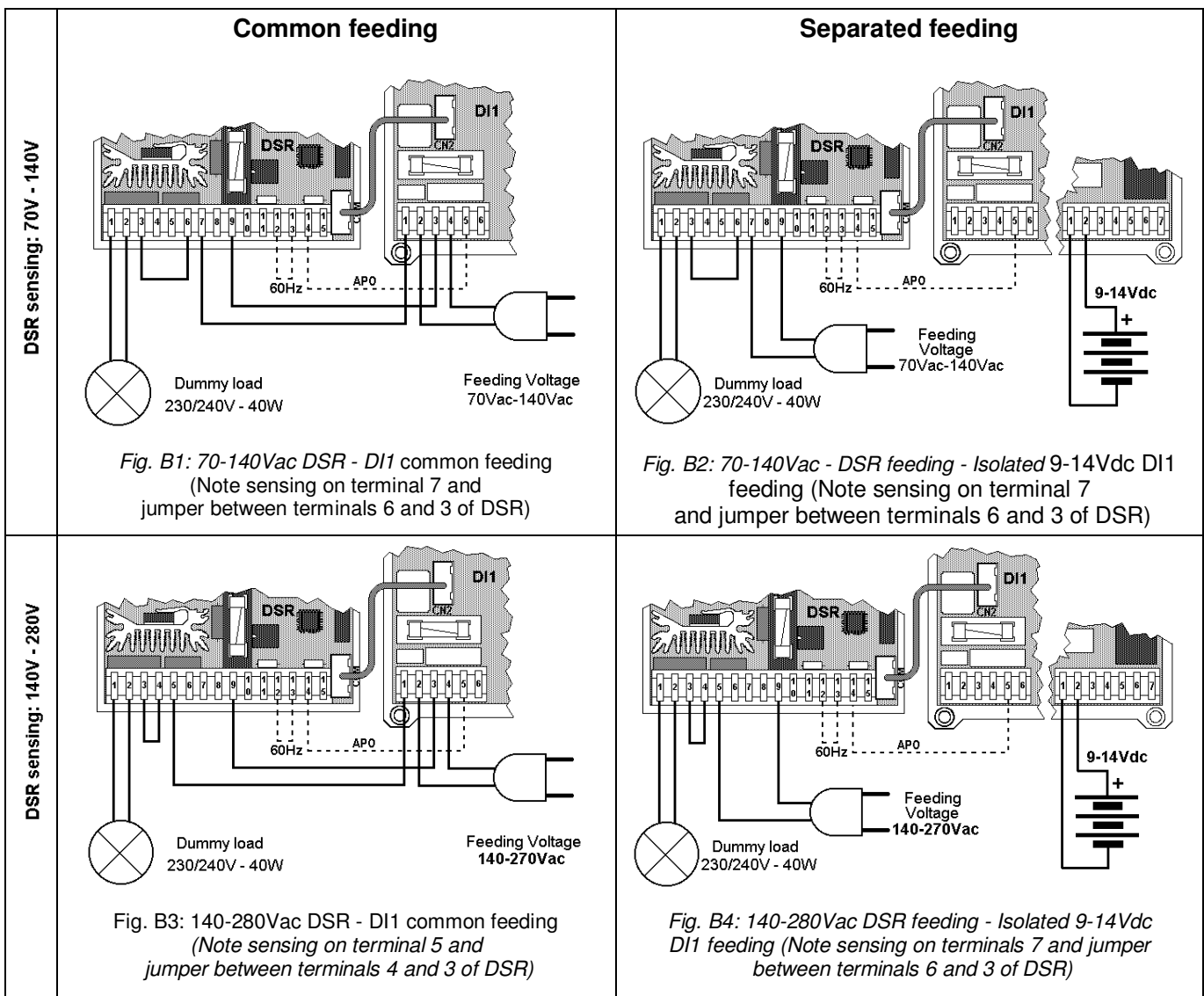

## REVISION HISTORY

<b>Revision</b>	<b>Date</b>	<b>Description</b>
rev.00	06/07	Initial Release
rev.01	05/08	Firmware update Rev. 7
rev.02	10/08	Firmware update Rev. 9, added Appendix A and Appendix B
rev.03	06/10	Firmware update Rev. 11, DSR/A
rev.04	10/12	Firmware update Rev. 15, added tables of STAB setting
rev.05	03/13	Added explanation of the file .alr and EMI filter SDR128/K connection diagram



Email: [parts@genpowerusa.com](mailto:parts@genpowerusa.com)



[www.meccalte.com](http://www.meccalte.com)

CALL US TODAY  
1-888-POWER-58

REQUEST A QUOTE  
[parts@genpowerusa.com](mailto:parts@genpowerusa.com)

SHOP ONLINE  
[www.genpowerusa.com](http://www.genpowerusa.com)